

# IL PULIZIJA



*Vol. 6 No. 10*



In 1975 Mid-Med Bank Limited was established to take over the business of Barclays Bank International Limited in Malta and Gozo. Barclays had originally taken over, 50 years earlier, the business of the Anglo-Egyptian Bank, which bank had been established in Malta since 1881! So, in reality, though we are only 10 years old, our foundations were laid over 100 years ago.

Since its formation in 1975 Mid-Med has increased Customers' Funds by 137% and Advances to customers by 88% – a truly remarkable growth!



**Mid-Med Bank Limited**

**HEAD OFFICE – 233 REPUBLIC STREET  
VALLETTA  
MALTA**

*The 10-year old Bank with  
over 100 years of experience*



# IL-PULIZIJA

LULJU/AWISSU 1987

Organu tal-Pulizija  
Stampat fil-Union Press  
Editur: PC 512 Martin Ellul

Bord Editorjali: Spettur J. Agius, Sargent Maġġur A. Sciortino,  
Sargent Maġġur L. Grey, Sargent 649 M. Saliba, Sargent 307 J.  
Calleja, Sargent 1303 G. Scicluna, PC 720 A. Borg.

## EDITORJAL

### Il-Pulizija u s-Socjetà

Nhar l-4 ta' Awissu, 1987 il-Pulizija Maltija rnexxiha ssolvi l-kaz maghruf tas-Serq tal-pittura ta' San Ġerolmu maghrufa ahjar bhala tal-Caravaggio. Pittura imprezzabbli u ta' wirt storiku ghal pajjizna. Dan kollu grazzi ghal dawk il-membri tal-Korp tal-Pulizija, li taht it-tmexxija tas-Supretendent Alfred Calleja, li flimkien ma' membri oħra tal-Forzi Armati ta' Malta, hadmu b'mod ghaqli, li fi kliem is-Supretendent Calleja stess kien xoghol li kien jirrekjedi segretezza u sorpriża. Barra minn dan kollu wiehed irid isemmi wkoll, kemm ix-xoghol taghna l-Pulizija jirrekjedi wkoll il-koperazzjoni tal-pubbliku ingenerali li huwa wkoll fattur importanti sabiex il-Pulizija Maltija tkun aktar effiċjenti.

Dan is-susanna għandu jservi ta' tagħlima kbira u l-Pulizija Maltija għandu jkollha kull stima mis-socjetà dwar dan u kazi oħra. Izda minn dan kollu wiehed irid jagħmel analiżi u jipprova jiskopri x'għandu jsir biex l-effiċjenza tal-Pulizija tkompli tikber.

Il-Board Editorjali ta' dan il-Perjodiku pprova jagħmel din l-analiżi u qiegħed jissuggerixxi li l-Korp tal-Pulizija għandu jkollu sezzjoni li tiehu hsieb ir-Relazzjoni mas-Socjetà in-general.

#### L-Iskop tal-Pulizija:

L-iskop prinċipali tal-Pulizija huwa "...li żżomm l-ordni u l-kwiet pubbliku, li ma thallix isiru reati, li tikxef u tinvestiga r-reati li jsiru..." u meta r-reat ikun sar "...li tigbor il-provi u li ggib il-hatjin, sew l-awturi kemm ukoll il-komplici, quddiem l-awtorità gudizzjarja", sabiex ikun jista' jsir haqq.

Fil-fatt il-protezzjoni tal-hajja u tal-propjeta, il-preservazzjoni ta' trankwillità fil-pajjiz u n-nuqqas ta' kriminalità biss joffru prova ta' kemm il-Pulizija hija effiċjenti u kemm fil-fatt dawk l-oġġettivi qegħdin jigu milhuqa. Għalhekk huwa mportanti li l-forzi kollha tal-Pulizija għandhom ikunu mmirati sabiex dawn l-iskopijiet ikunu attwati.

Fattur importanti li wiehed għandu jiftakar hu li l-membri tal-Pulizija gejjin minn kull klassi tas-socjetà u dawn jiddependu hafna fuq il-fiduċja u l-koperazzjoni ta' kull ċittadin. Barra minn dak li semmejna hawn fuq, wiehed irid iżid ukoll li l-Pulizija jrid jiftakar li hu d-dmir tiegħu li jiprotegi u jgħin lill-membri tas-socjetà u jrid iħares

Ikompli f'pagna 2

## KOPERTINA:

Il-pittura imprezzabbli tal-qtugħ tar-ras ta' San Gwann Battista tal-famuż Caravaggio.

Ritratt tal-kopertina meħud minn P.C. 720 A. Borg.

## F'Din il-Harġa

Mill-Assoċjazzjoni tal-Pulizija.....	2
The St Jerome's Lessons.....	3/4
Relazzjonijiet Pubblici mill-Pulizija.....	5
Inspector John Agius - Graduate of the Institution of Analysts and Programmers.....	6/7
Firearms.....	8/9
Driving Under The Influence of Drink and Drugs.....	10
Il-Pulizija u l-Eżercizzi Fiziċi.....	11/12/13
Well and Bravely Done, S.M.U.....	13
Defamatory Libel and The Plea of Fair Comment.....	14
Lehen l-Għaqda tal-Pulizija Pensjonanti.....	15/16/17/18
Paġna għan-Nisa.....	19
Subscription to the International Criminal Police Review.....	20/21
Paġna għat-Tfal.....	22
Tisliba bi premju.....	23
Mid-Dinja Muzikali.....	24
Id-Dritt u Dmir tal-Pulizija.....	25
Nies Maghrufa.....	26
L-Akkwarju.....	27
Qtill Waqt Loghba Poker.....	28
Admissibility of Post Hypnotic Testimony.....	29
Sports.....	31/32

Riferenza għal Magazine "Il-Pulizija", harġa Mejju/Gunju 1987, nixtiequ ninfurmaw lil qarreja li n-Numru Vol. 6 Nru. 10 deher bi żvista u kellu jinqara Vol 6. No. 9.

# MILL-ASSOĊJAZZJONI TAL-PULIZIJA

• DAN l-aħħar smajna hafna dwar ix-xogħol li tagħmel il-Pulizija kif ukoll dwar il-kundizzjonijiet tax-xogħol li għandhom l-istess membri. Kulhadd jaqbel li l-Korp tal-Pulizija għandu jaqdi d-doveri tiegħu bl-aktar mod serju u effiċjenti kif ukoll kulhadd jaqbel li l-kundizzjonijiet tal-membri għandhom jkunu jirriflettu sew fil-hinijiet kif ukoll fil-paga mas-sagrifiċċji li l-istess membri kif ukoll il-familji tagħhom jagħmlu. Hemm bżonn li l-Pulizija tkun stmata bir-rispett u d-dinjità li jixriqilha u mhux tiġi wżata bħala makna li minnha tiegħu biss mingħajr ma ttiha xejn ħlief forsi xi kultant 'service' regolari, irridu niftakru li l-membri tal-Korp huma bnedmin bhal haddieħor li jhossu sew dak li hu tajjeb kif ukoll dak li jkun hażin.

L-Assoċjazzjoni tal-Pulizija minn dejjem sostniet mal-membri tagħha sabiex il-Pulizija taqdi dmirha skond il-gurament li hadna u fit-talbiet tagħha dejjem kienet prudenti billi dejjem insistiet għal aktar effiċjenza sabiex din minbarra li ttejjeb is-servizz tagħna tkun tista' wkoll tirrifletti fuq ir-rizultati tax-xogħol tagħha u b'hekk il-pubbliku jkun moqdi aktar, għalhekk fuq il-kundizzjonijiet tax-xogħol ahna dejjem insistejna bl-istess qawwa fuq id-drittijiet tagħna mingħajr ebda misthija jew riserva.

Kulhadd jaf li skond l-Ordinanza tal-Pulizija l-poteri tagħna fejn tidhol l-Assoċjazzjoni tal-Pulizija hija ristretta hafna dwar kif isiru t-trattativi dwar it-talbiet tagħna, izda jkun abbuż serju minn min hu responsabbli li jisma' dawn it-talbiet gusti li nressqu u jibqa' passiv minhabba li kif għedna aktar qabel ma nistgħu nieħdu ebda passi oħra għajr li nitolbu u nressqu dawk it-talbiet għad-drittijiet tagħna izda minhabba r-restrizzjonijiet li hemm imposti fuqna permezz tal-Ordinanza tal-Pulizija.

Ahna m'ahniex ninsistu għal dawk id-drittijiet li għandhom haddiema u Unions oħra, u dan għaliex ahna responsabbli u nemmnu li fejn ikun hemm rieda tajba min-naħat kollha konċernati dan ikun jista' jwassal għal ftehim gust mingħajr l-ebda bżonn ta' sagrifiċċji minn hadd, għalhekk nappellaw lill-Awtoritajiet responsabbli sabiex iqisu dan li qeghdin ngħidu u jittrattaw magħna bl-irgūlija li jisthoqqilna.

Matul l-aħħar elezzjonijiet generali li nżammu f'pajjiżna kien hemm xi setturi ta' mpjegati li hadmu iżjed minn normal minhabba li kien hemm volum ta' xogħol aktar mis-soltu, dan il-

**Rapport mis-Surgent**

**649 M. SALIBA**

**Segretarju,  
Assoċjazzjoni tal-Pulizija**

fatt gie aċċettat mill-Awtoritajiet fejn saru diversi dikjarazzjonijiet u stqarrijiet pubbliċi, u li għustament dawn irrikkomandaw kumpens għal dawn il-haddiema. Il-Korp tal-Pulizija f'dawk il-granet u minn diversi xhur qabel matul il-kampanja elettoralni hadem hafna sigħat zejda u li s'issa ma gejniex ikkumpensati għalihom.

Fi zminijiet normali l-membri tal-Korp tal-Pulizija diġa qeghdin jahdmu aktar minn normal bhal ma jahdmu haddiema oħra li bil-Ligi dawn iridu jahdmu l-mas-simu ta' gimgha ta' 40 siegħa u li din ilha tezisti għal dawn l-aħħar hmistax-il sena. Il-membri tal-Pulizija għadha sal-lum minkejja t-talbiet tagħha sabiex nigu nahdmu daqs haddiema oħra minkejja l-wegħdiet li saru minn kull naħa, aktar u aktar meta kif semmejt aktar 'il fuq waqt il-kampanja elettoralni li għaddiet kemm sigħat zejda hdimna mingħajr ma biss dawn gew irregistrati bl-iskuża li waqt dan iż-zmien ma hemmx limitu għat-tul ta' hin ta' xogħol.

Għal dawk li jirragunaw nekk ngħidulhom li fid-dinja għal kollox hemm il-limitu tiegħu. Nittamaw li l-Awtoritajiet konċernati jirrikonoxxu bil-fatti dwar dan li qeghdin ngħidu, u tispiċċa l-mentalità li għax ikun hemm xi allegazzjonijiet ta' abbużi minn xi individwi tingibed kundanna għall-membri kollha tal-Pulizija. Jekk jiġi ppruvat li xi hadd naqas, jittieħdu l-passi ta' dixxiplina li hemm bżonn issir izda nerga' ntenni li ma nigbdux kundanni generiki. Dan qieghed

ngħidu għaliex dawn l-affarijiet saru fl-imghoddi u kien hemm diversi każi fejn il-Pulizija ma haditx dak li hadmet għalih minhabba dawn il-pregudizzji li kienu jezistu kontra l-Korp tal-Pulizija.

Suġġett li xtaqt nikteb dwaru huwa fejn jidhol l-ambjent li fih hafna mill-membri tal-Korp jqa-tgħu waqt iż-zmien li jkunu jser-vu bħala membri fil-Korp. Dan li qieghed nirreferi għalih huwa l-post tax-xogħol jiġifieri l-Għases tal-Pulizija, b'sodisfazzjon qeghdin ninnotaw li kwazi l-Għases kollha qeghdin jingħataw face lift għida rigward manutenzjoni u dehra generali, dan kien wieheċ mit-talbiet persistenti tal-imghoddi li l-Assoċjazzjoni dejjem tkellmet dwaru, li nixtiequ huwa li wara li jsiru x-xogħlijiet meħtieġa ma jiegqafx kollox hemm izda jibqa' jsir dak ix-xogħol regolari ta' zebgħa u manutenzjoni meħtieġa regolament sabiex id-dehra ta' l-Għases tibqa' kif verament jixraq għad-dekor ta' l-istess Korp.

Appell li nixtieq nagħmel lill-membri kollha huwa sabiex kulhadd jibza' għall-indafa bhal ma kulhadd jagħmel meta jkun f'daru, ma rridux ninsew li parti sew minn hajjtna nqatgħuha gewwa l-Għassa tal-Pulizija li tista' titqies bħala t-tieni dar tagħna.

Fl-aħħar nerga' ntenni sabiex ilkoll naqdu dmirna kif marbutin bil-gurament bl-akbar fedeltà lejn pajjiżna u l-Kostituzzjoni u bl-istess dritt u serjetà ninsistu għad-drittijiet tagħna.



**PULVICH  
EXPLOSIVES  
INDUSTRIES**

Manufacturers & Suppliers of Mining Explosives and accessories  
Propellant powders, sporting ammunition and Deep Rock  
Drilling machines.

**"PULVICH HOUSE"**

101, ARCHBISHOP STREET, VALLETTA

TEL.: 225287-607707

## THE ST JEROME'S LESSONS

By Senior Inspector  
**ANGELO FARRUGIA**  
(Dip. Cons. Administration Malta)

□ ON THE 29TH OF DECEMBER 1984 in the afternoon, the precious painting of St. Jerome by Caravaggio was stolen from the museum of the Con-Cathedral of St. John at Valletta. This theft shocked Malta especially those who have close to their hearts the Maltese artistic heritage. This painting besides being one of the most important paintings by Caravaggio, has a great artistic value in the world. It was both a loss to Malta and the world Students studying art spend hours and hours appreciating this St. Jerome painting. That day, I did not form part of the investigating group.

Years passed, and although I am aware that intensive investigations were carried out this painting remained missing. There were many rumours that this painting was somewhere abroad probably in Europe and at one stage even USA was mentioned. Interpol was asked to assist and informations were exchanged. Months ago there was an important development at executive level in respect to this investigation and this was passed to the present government following the change of power last May and thanks to the team effort of the members of the Police Force and the Task Force under the leadership of the dedicated, intelligent, and experienced police Superintendent Alfred Calleja, who returned back to the Force after some years of absence, this painting of St. Jerome, was found in good condition on the 4th of August 1987 in a place here in Malta.

After its discovery several persons were arrested and investigated. Two days later, two persons were arraigned in court and charged accordingly. About the case and the investigation it is not proper to discuss as the case is still sub-judice and the investigation is still at its early stages.

However, notwithstanding this great success, the recovery of St. Jerome painting by Caravaggio, has much to teach. It is a lesson to the authorities who have to provide adequate security to our museums especially in those places where such work of arts are permanently exhibited. It is a lesson to all politicians where cooperation at high level is essential and has proved to lead to the best results as it did in the Caravaggio's case. It is a lesson to the Police Force where team work must be an asset in most investigations in order to achieve the best results (Supt. Alfred Calleja was assisted by four Police

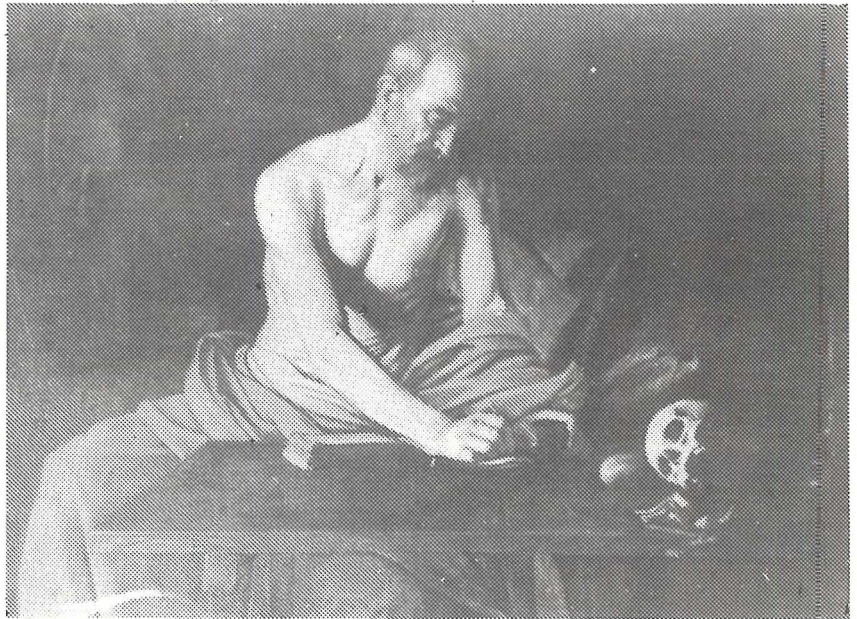

Inspectors, a number of sergeants, constables and also members of the Task Force). We should NOT let our ambitions to run wild. As long as we think of one whole Police Force, we should not try to limit ourselves to personal esteem, prestige and gains. Individualism in police investigations is no longer the formula and I cannot remember when it really was.

Our aims must be collective and must be stramed only to improve the image of the Police Corp, organise ourselves, solve as many crimes as possible, and keep ourselves away from any political influence as is clearly stated in the Police Ordinance. Keeping these in mind, we will show the world how efficient and ideal our Police Corp is. We will be the admiration of other Police Forces abroad. Most definitely the Caravaggio's case has already put us in the right direction. We need now to follow this direction with greater determination.

Of course there are other les-

sons that we have to learn from the discovery of the St. Jerome painting. I cannot not mention the fact that we are still amateurs in the art of surveillance. We need to team more how to shadow properly a person or a vehicle, without letting ourselves to be exposed too far. We should have a group of members of our Force that must undergo proper training in the exercise of surveillance. Having these people trained, whenever the need arises, we will always be prepared to carry on any other task.

Caravaggio whose real name is Michelangelo Merisi dies in 1610, and nearly 300 years after, we are still learning how to investigate (thanks to St Jerome) besides appreciating his genius.

**Il-messagg tas-Supt. Alfred Calleja fl-okkazzjoni tas-sejba tal-pittura ta' Caravaggio qiegħed f'pagna 4.**

serie brava

**Have you placed your  
order?  
Many others have, and  
they made a bargain! So  
why not you? — When for  
only**

**Lm150**

**you can get a first quality  
bathroom suite complete  
with "Grohe" chrome  
fittings and twelve colours to  
choose from!**

**LAILA  
CERAMICS**

740 HIGH STREET, HAMRUN

*Il-Prim Ministru l-Onor Eddie Fenech Adami, flimkien mal-Viċi Kap u Ministru tal-Gustizzja, l-Onor. Guido Demarco u l-Ministru ta' l-Edukazzjoni u Sport, l-Onor. Ugo Mifsud Bonnici, ma' uffiċjali u Membri tal-Korp tal-Pulizija, fl-Officers' Mess tad-Depot tal-Pulizija, wara s-sejba tal-pittura imprezzabbli tal-Caravaggio.*



## IL-PULIZIJA U S-SOĊJETÀ

### **Ikompili minn paġna 1**

*lejh innifsu bhala servjent u għassies tad-drittijiet tas-soċjetà. Il-Pulizija jrid jiftakar ukoll li hu parti mis-servizzi soċjali li joffri l-pajjiż.*

### **Relazzjonijiet Pubblici:**

*Dan is-sugġett jehtieg li jigi nvestigat tajjeb. Minghajr il-koperazzjoni tal-Pubbliku, ix-xogħol tagħna huwa ferm diffiċli. Aħna qegħdin nissuggerixxu li titwaqqaf Sezzjoni fi hdan il-Korp sabiex issegwi, tkabbar u żżomm kuntatt mal-Pubbliku. Din is-Sezzjoni għandha tiffirma parti minn Dipartiment ta' Informazzjoni Pubblika dwar ix-xogħol u l-attività tal-Korp tal-Pulizija.*

*Ix-xogħol ta' din is-Sezzjoni għandu jkun ibbażat sabiex il-Pulizija ssir taf aktar mill-qrib il-htigijiet tal-Pubbliku u sabiex il-Pubbliku jsir jaf aħjar lill-Pulizija u x-xogħol tagħha. Kull attività tal-Pulizija għandha tingħata pubbliċità fil-mezzi kollha tax-Xandir sabiex il-kuntatt tal-Pulizija u s-soċjetà jkun kontinwu.*

*Din is-Sezzjoni għandu jkollha bhala funzjoni – l-istharrig tad-delinkwenza fost iż-żgħażaġh, l-Ambjent fil-lokalitajiet, il-htigijiet fil-Komunità kif ukoll li twassal dak kollu li l-Pulizija tagħmel inkonnessjoni mas-Soċjetà. Bhala għan ewlieni din is-Sezzjoni għandha żżomm bhala l-oġġettiv prinċipali “Il-Koperazzjoni tas-Soċjetà mal-Pulizija u vice versa”. Barra minn dan, din is-Sezzjoni trid tkun minn ta' quddiem biex tgħallem lis-Soċjetà dwar ‘Crime Prevention’ u bil-mezzi tagħha twassal informazzjoni teknika f’dan ir-rigward. Hawn ta' min isemmi li parti minn dan ix-xogħol diġà qiegħed isir permezz ta' dan il-Perjodiku, iżda dan mhux bizzejjed.*

### **Suċċess jew falliment:**

*S'intendi, sabiex xi haġa tirnexxi trid l-ewwel tifrex is-sodda jew inkella flok suċċess tasal għall-falliment ta' dak li tkun qiegħed tipprova tagħmel. Biex dan kollu jkun jista' jsir, din is-Sezzjoni jrid ikollha speċi ta' ‘Liaison Officer’ li jkun responsabbli minn distrett partikulari. Fattur iehor importanti hu wkoll li dan il-‘Liaison Officer’ waħdu ma jistax ilaħħaq ma' kollox. Għalhekk dan għandu jkun biss ko-ordinatur ta' l-attività kollha li ssir fid-Distrett li tiegħu ikun responsabbli.*

*Bhala parti mix-xogħol tiegħu, il-‘Liaison Officer’ għandu jkollu l-funzjoni li: (1) Jinkoraggixxi u jikkordina attivitajiet bejn il-Pulizija u l-kumplament tas-Soċjetà fid-Distrett tiegħu; (2) Li jassigura li l-membri kollha tas-Soċjetà fid-Distrett tiegħu jafu u jifhmu r-rowl tiegħu; (3) Jassigura li l-Pulizija fid-Distrett jifhmu sew il-problemi tal-komunità u li kapaċi joffru alternattiva għas-soluzzjoni tagħhom; u (4) Li jkollu superviżjoni kompleta taz-Żgħażaġh. Dan għandu jkun mghejjun min-numru ta' Beat Officers, liema sistema għandha terġa' tigi ntrodotta. Ara l-artiklu “Relazzjonijiet Pubblici” f’paġna 5.*

● *Tajjeb wieħed ikun jaf x'qal il-moħħ ta' wara din l-operazzjoni s-Supt. Alfred Calleja, ftit minuti biss wara s-sejba tal-pittura ta' San Gilormu tal-Caravaggio fl-Officers Mess fil-preżenza tal-Prim Ministru Onor. Dr Eddie Fenech Adami LLD, il-Ministru tal-Gustizzja u Intern Onor. Dr. Guido Demarco LLD MP, u l-Ministru ta' l-Edukazzjoni, Kultura u Sports, Dr. Ugo Mifsud Bonnici LLD, MP.*

*“Nixtieq inżid kelma ta' r i n g r a z z j a m e n t . Niringrazzja l-ewwel nett lill-Ispettur Anglu Farrugia, l-Ispettur Charles Galea, l-Ispettur Paul Sammut, u t-team tiegħi kollu li tant hadmu f'din l-operazzjoni. Niringrazzja lill-membri kollha ta' SMU taht it-tmexxija ta' l-Ispettur Charles Cassar, li kienu strumentali f'din is-sejba, kif ukoll lill-Kurunell Maurice Calleja u l-membri tat-Task Force kollha, li hadu parti u li wkoll kienu ferm strumentali, kif ukoll il-membri tal-Control room.*

*Lil dawn kollha nitlobhom skuza għaliex żammejthom fid-dlam rigward x'kien qed jigri sa l-aħħar mument, biss jiena persważ illi llum kollha jirrealizzaw illi operazzjoni ta' din ix-xorta tirrekjedi żewġ fatturi importanti li huma segretezza u sorpriża.*

*Is-segretezza żammejniha u s-sorpriża tajniha”.*



# FAMOS

DOMESTIC  
APPLIANCES

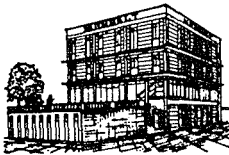

## MARBELT

Department Stores

CROSS ROAD,  
MARSA

Tel. 223197,  
607966

# GEORGE BARTOLO

GENERAL MERCHANT  
IMPORTS & STOCKISTS

*MEMBER OF ASSOCIATED DISTRIBUTORS*

10, MILE END STREET - HAMRUN

TEL: 628620 - 225180

*General & Foodstuffs Wholesaler*

- A.D.L. JAM PRODUCTS
- HANS STEINHAUSER CHEESES,  
PEPATO, ROMANO, KEFALOTIRI

# This one's for me, diet Coke.

Now for you in Malta  
the great taste of diet Coke ...  
the real Cola taste with just  
**ONE CALORIE.**

For looking good and  
feeling good.

The taste is right. It's diet Coca-Cola.



Great taste. ONE CALORIE.



'diet Coke' and 'diet Coca-Cola' are trade marks of the Coca-Cola Company

# Relazzjonijiet pubbliċi mill-Pulizija

□ DAN l-artiklu jkompli ma' l-Editorjal ta' din il-harga. Wiehed irid jiftakar li xoghol ta' relazzjonijiet pubbliċi ma jistax isir minn persuna waħda. Irid ikun hemm xi hadd li jzomm kuntatt dirett mas-soċjetà. Dan ix-xoghol jista' jsir minn Beat Officer.

## □ Il-Beat Officer:

Dan ix-xoghol jitlob dedikazzjoni kbira mil-'Liaison Officer' konċernat u dan ix-xoghol kollu li semmejna jista' jagħmlu biss meta jirnexxilu jsir jaf tajjeb il-komunita ta' madwaru u wkoll meta l-komunita ta' madwaru issir taf lilu. Dan jista' jintlaħaq biss bis-sistema tal-Beat Officer. Ix-xoghol tal-Beat Officer inqata' minħabba l-fatt li s-soċjetà tbidlet u l-Pulizija saret aktar mobili u bdiet tuża' mezzi aktar effiċjenti ta' trasport, eċċ.

Il-Beat Officer, li fl-Ingilterra huwa magħruf aħjar bhala l-Village Bobby, kien għin hafna lill-Pulizija biex iżomm kuntatt dirett mal-pubbliku. Fl-Ingilterra, dan kien iservi bhala l-habib persunali tal-Komunità, dejjem lest biex jgħin u fl-istess hin kien iżomm għajnejh fuq dak kollu li jgħri madwaru b'hekk inħolqot ċerta fiduċja f'dan il-Beat Officer li kien qiegħed hemm biex jassisti lill-komunità meta jkun hemm il-htieġa.

## □ Il-Liaison Officer u l-Beat Officer:

Essenzjalment, ir-rowl tal-Pulizija fis-Soċjetà huwa li jzommu bilanċ, liema bilanċ, hafna drabi jkun jiddependi minn hafna fatturi. Min-naħa l-waħda, il-Pulizija trid tinforza l-liġi kif magħmula mir-rappreżentanti tal-poplu fil-Parlament u min-naħa l-oħra dawn iridu jggarantixxu l-libertà ta' l-individwu.

Biex dan ikun jista' jsir, il-Pulizija trid iżzomm bilanċ bejn il-htigijiet taċ-ċittadin bhala individwu u l-htigijiet tal-komunità in-general li wara kollox l-istess Pulizija huwa parti minnha.

Is-sigriet tal-Pulizija sabiex ikollha suċċess biex iżzomm dan

il-bilanċ u fl-istess hin tinforza l-liġi huwa li tkun kapaċi tagħmel dan b'reqqa, b'dehen u b'deskrizzjoni u fuq kollox b'ċertu libertà kostituzzjonali fejn il-Pulizija tkun kapaċi u libera li tagixxi fuq il-kuxjenza u b'responsabbiltà kbira individwali tal-membri tagħha. Dan żgur li mhux faċli.

Għalhekk, il-Liaison Officer flimkien mal-Beat Officer għandhom iżommu kuntatt dirett mas-setturi kollha fid-Distrett tagħhom. Għandhom ikollhom il-hin li jipparteċipaw f'kumitati lokali ta' Għaqdiet taż-Zgħażaġh, dawk sportivi, Għaqdiet Civiċi u Kunsilli Parrokjali.

Dawn, flimkien għandhom jipplanaw u jorganizzaw speċi ta' programm għall-iskejjel tal-lokal. Għandhom jorganizzaw diskussjonijiet għat-tfal ta' l-Iskejjel mhux biss biex jikellmu mat-tfal, iżda wkoll biex jiltaqgħu ma' l-għalliema. Għandhom ukoll jorganizzaw wirjiet dwar per eżempju "Il-Pulizija fis-Soċjetà"; "Il-Liġi Kriminali"; "Road Safety" u "Id-Drittijiet u Dmirijiet taċ-Ċittadin", eċċ. Laqgħat oħra jistgħu jsiru wkoll ma' l-Assoċjazzjoni Genituri u Għalliema. Dan kollu jiffirma dawk li jissejthu 'lines of communication' fost is-soċjetà u jiffirma karattru għid fost iż-zgħażaġh minn mindu jkunu ta' età żgħira. Meta jsiru diskussjonijiet mat-tfal, l-istess tfal ikollhom iċ-ċans li jikellmu mal-Pulizija mingħajr konfrontazzjoni. Dan kollu jwassal biex tinbidel l-attitudni tas-soċjetà li jahseb li l-Pulizija hija biss xi mostru ta' awtorità.

Dawn it-tip ta' attivitajiet u diskussjonijiet kif ukoll wirjiet m'għandhom biss ikunu magħ-

Mill-Ispettur  
JOHN AGIUS

luqa għat-tfal ta' l-iskejjel iżda għandhom ikunu miftuħa għal dawk l-Għaqdiet li jitolbu lil xi membri tal-Pulizija biex imorru jagħmlu diskussjonijiet, eċċ ... fosthom.

## □ Ir-Riżultat:

Aktar ma l-Liaison Officer u l-Beat Officer jipparteċipaw fost il-hafna għaqdiet fil-Lokal tagħhom aktar ikun iċ-ċans li dawn isiru jafu l-htigijiet tal-komunita. Għalhekk parti oħra tax-xoghol ta' din is-sezzjoni għandha tkun li huma stess, cioè il-Liaison Officer u l-Beat Officers, għandhom ifittxu u jstiednu lilhom infusom għal attivitajiet fost il-komunità.

Ma' dan kollu, din is-sezzjoni għandha tipprova toħloq kuxjenza diretta fost il-komunita billi tissuggerixxi lil dawk il-hafna għaqdiet sabiex jorganizzaw ċerti attivitajiet. Kemm il-Beat Officer u l-Liaison Officer għandhom ipogġu fuq ċerti Kumitati u jippruvaw iħeggu attivitajiet fost iż-zgħażaġh bla xoghol. Kultivazzjoni dwar housing schemes biex jitnaqqas il-vandalizmu. Għandhom jgħinu lill-vittmi tal-kriminalità u jgħinu wkoll lil dawk li għal xi raġuni jew oħra ġew aljenati mill-kumplement tas-soċjetà.

## □ Inzomm u l-Poplu Infurmat:

Għalkemm dan ix-xoghol minn din is-sezzjoni jista' jiswa ta' gid, wiehed irid iżomm f'rasu li hafna nies għandhom kuntatt żgħir jew m'għandhom ebda kuntatt mal-Pulizija. Dawn in-nies jiddependu hafna fuq it-Televizjoni u Radju u l-Gazzetti. Fil-fatt din il-parti tas-soċjetà tista' biss tiffirma idea tal-Pulizija minn dawn il-mezzi ta' komunikazzjoni. Għalhekk huwa ferm importanti li din l-informazzjoni tiġi mghoddija b'eżattezza kbira lil dawn il-mezzi tax-xandir.

## □ Konklużjoni:

Jekk il-Pulizija Maltija jirnexxilha tibni sezzjoni bhala din,

**Ikompili f'pagna 7**



**Inspector John Agius**

**Graduate  
of the  
Institution  
of Analysts  
and  
Programmers**

**THE INSTITUTION OF  
ANALYSTS & PROGRAMMERS**



*This is to Certify that*

JOHN AGIUS

*having successfully completed an  
approved course of instruction at*

THE DATATECH COMPUTER CENTRE

*was duly Elected a*

GRADUATE

*of the Institution of Analysts & Programmers*

*on the Twenty-Fifth day of June 1987.*

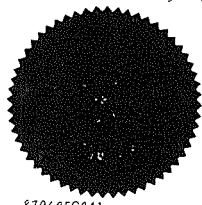

8706250841

Given under the Seal of the Institution  
in the Presence of

President

General Secretary

**INSPECTOR John Agius has recently successfully completed an approved course of studies in Computer Systems and was awarded Graduate Membership of the Institution of Analysts and Programmers (U.K.). The Institution awarding its membership to Inspector J. Agius is a UK based Organisation for the advancement and greater recognition of the Profession of Systems Analysts and Computer Programmers.**

Inspector John Agius is now entitled to use the designatory letters Grad. I.A.P. He is also entitled to use the Institution's bearings and the Institution's Data Process Contract for his professional business free of any royalty or other charges.

The course was based on Computer Concepts, Systems Analysts, Computer Programming, High Level & Fourth Generation Languages and the various Operating Systems used in today's Computer Technology.

This professional qualification is recognised in over 50 countries

and should stand him in good stead in his future. Inspector J. Agius wishes to further his studies in the field of Computer Science by specialising in Data Processing Management.

Inspector John Agius has studied Electronics at the Paola Technical Institute for Further Education between 1971/76. During this period he obtained certificates from the City & Guilds of London Institute. Later, in 1976 he studied Journalism & Professional Writing with The Trans World Tutorial College (U.K.) where he was

awarded a Diploma in the subject.

During 1981 to 1984 he attended for an evening course leading to a certificate in Supervisory Management organised by the University of Malta. When he later joined the Malta Police Force in September 1984 as a Police Inspector he attended another course at the University of Malta leading to a Diploma in Law & Administration. He also attended other courses connected with Police Work. Lately, Inspector J. Agius, was appointed as Member on the Government Committee for Legal Data Processing. This Committee is within the Ministry of Justice and is aimed at studying the possibility of introducing a computerised system at the same Ministry.

His interest in Computers started way back in 1973 when he

## – Graduate of the Institution of Analysts

●Continued from page 6

was studying Electronics. Then he sat for an examination to attend a course in Computer Operations at London, England. Although he was the leading student in the examination he had to withdraw his nomination due to financial problems. However he continued his studies on personal basis.

Between 1978 and 1981 he had the opportunity to take part in the implementation of a computer system abroad when at that time he was employed as Personnel Officer with an Italian Construction Company. When he returned to Malta in 1981 he worked on computers with a local firm. Then, in 1982 he joined the Multi-National Italian Semi-conductor Company SGS(Ates) as a supervisor engag-

## and Programmers

ed in the Testing and Finishing process of computer and other electronic components.

From SGS(Ates) he joined the Malta Police Force as Police Inspector. Since then he has served at district – “D:F & H Divisions” – at the same time for almost five months; At the C.I.D. for about one and a half years and since February 1986 he has been stationed at the General Head Quarters in charge of the General Records Branch which is composed of the (a) Statistics Office; (b) Criminal Records Office; (c) Principal Citations Office, including Prosecution at the Evasion of Duty sitting & PAPB sittings; (d) Co-ordinator and Prosecutor at the Juvenile Court Sitting; (e) Civil Status Office; (f) Weapons Office, including Fire-

Works Factories and Quarries licences; (g) National Identity Cards Office; (h) Price Control Section and (i) Liaison Officer for the Implementation of a Computer System for the Police Department.

He has also dedicated his free time as member of the Officers Mess Committee for two consecutive years. He is the Chairman of the Welfare Committee and for the last three years as member and now Chairman of the Editorial Board of this Magazine – IL-PULIZIJA – which is the official organ of the Malta Police Force.

As liaison officer in the implementation of a Computer System for the Police Force he has contributed a lot. Such a system is considered one of the largest on the Island and its implementation is in its advanced stage and it is expected that it will be in operation in the very near future.

### RELAZZJONIJIET PUBBLIĊI MILL-PULIZIJA (Ikompli minn paġna 5)

I-stess Pulizija tista' tkun f'pozizzjoni aħjar dwar għajnuna li tista' tigi mis-soċjetà. Il-poplu jitgħallem aħjar kif għandu jikkomunika mal-Pulizija. Il-poplu jitgħallem jgħin aħjar lill-Pulizija fix-xogħol tagħha. Il-poplu wara kollox jitgħallem li meta jsir jaf b'xi haġa li tkun saret kontra l-ligi, huma jinfurmaw mill-ewwel lill-Pulizija għaliex wara kollox il-poplu jinduna li meta l-Pulizija jirnexxilha ssolvi kazi kriminali u oħrajn bil-għajnuna tagħhom dawn ikunu qegħdin jghinu lilhom infushom.

L-Ingliz jgħid “Vandalism and Crime – Suddenly it comes home to you”. Dan għandu jkun il-messaġġ prinċipali lis-soċjetà minn din is-sezzjoni fi hdan il-Pulizija.

### L-Assoċjazzjoni tal-Pulizija (M.P.A.)

Hija xewqa ta' l-Għaqda tal-Pulizija Pensjonanti, li l-Awtorità tal-Pulizija tagħti attenzjoni lill-Assoċjazzjoni tal-Pulizija u tikunsidra l-pozizzjoni tat-tmexxija tagħha.

Kif inhi kostitwita l-M.P.A., bl-Awtorità tal-Pulizija hija parti integrali mill-istess Assoċjazzjoni ma tistax tressaq ilmenti la quddiem l-Official Side u aktar u aktar quddiem l-Awtorità Kompetenti jew il-Ministru tal-Pulizija.

Wiehed irid jikkunsidra li l-membri tal-Korp la jistgħu jippartecipaw u lanqas ikunu membri ta' għaqdiet trejdnjonistieci bħal impjegati oħra u per konsegwenza ma għandhomx min iressqilhom l-ilmenti tagħhom. Ir-Regulamenti li jiffurmaw il-Kostituzzjoni ta' l-M.P.A., huma limitati u mrazzna mill-Ordinanza tal-Pulizija ta' l-1961, li giet implimentata meta Malta kienet taht stat ta' emerġenza u ma nbidlet qatt.

Għalhekk aħna tal-fehma li wara 25 sena din l-Ordinanza għandha ssir aktar liberali u ndipendenti u tinghata awtonomija sħiħa lill-M.P.A., biex barra li l-“welfare” ikun aktar protett, ikunu jistgħu jitressqu u jigu diskussi mingħajr diffikultà l-htigijiet tal-membri tagħha ma' l-Awtoritajiet konċernati.

LORRY MUSCAT,

## Donation of Lm200 to PC V. Zammit

●A TORRENTIAL rainstorm occurred on the night of 31st January, 1987 and as a result of which the residence of PC 818 V. Zammit at Żabbar was inundated with water causing loss of household items and furniture amounting to Lm800.

The Board of the Police Welfare Committee was asked to allviate the hardship sustained by PC Zammit and after due consideration and examination of claim it was decided to assist in part towards the cost of replacing such household goods.

PC Zammit was donated the sum of Lm200 drawn out of the Police General Fund.

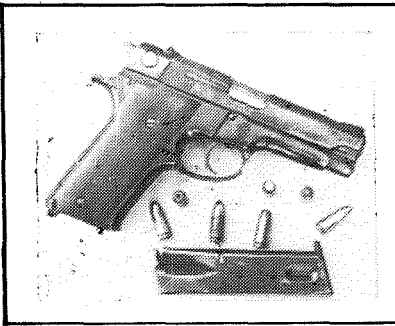

# FIREARMS

By  
**P.S. 1315**  
**E. SAMMUT**  
**(BALLISTICS UNIT)**

PART 6

## THE WEBLEY .22 RF MARK VI 1918

In order to produce expenditure of expensive .455 ammunition, and also to encourage shooting on simple indoor ranges, a .22 version of the Mark VI was made for training only. The cylinder and barrel were changed, but the remainder of the revolver was a standard Mark VI, thereby giving a realistic feel to the shooter. The cylinder was much shorter than the standard one, and the barrel was brought back into the frame to meet it; this leaves a large gap in front of the cylinder, which immediately identifies the model. A round .22 barrel was fitted, and a raised foresight was needed to bring the blade into line with the backsight.

## POLICE AND CIVILIAN MODELS OF THE GOVERNMENT REVOLVER

Throughout the manufacture of the government models, there was a parallel production of civilian and police versions, although in .38 calibre, and occasionally in .32. All of these revolvers followed the same pattern as the larger military models, and they also enjoyed the same high reputation for reliability and resistance to rough handling. The following detailed descriptions are intended to highlight the features of each model.

## MARKS II AND III 1896-1897

The Mark II was described as a pocket revolver, though it would have needed a large pocket to take it. The barrel was 4 inches long and this combined with a six-chambered cylinder made a somewhat bulky handful. The butt was a shortened version of the rounded 'bird's head' with a hump behind the hammer to pro-

tect the web of the thumb at full cock. The cylinder released was the improved type introduced with the 1892 Model, as was the barrel latch, but the hammer spur had more of a curve to it than had the larger models. Some had lanyard loop, but this was not fitted to all, and it was omitted from the Mark III.

All Mark IIs and IIIs had the half-round cylinder flutes and chamfered ends to the cylinder, though there were no holster guides. Both versions were produced with conventional hammers and flat-faced hammers with strikers.

The Mark III abandoned the curved butt and had a short square-ended butt that possibly gave a better grip; in all other respects, it was unchanged from the Mark II, though some police models fitted a thumb safety catch on the right-hand side, which locked the hammer down.

## W.S. ARMY AND BISLEY TARGET REVOLVERS, 1904

In 1904 Webley and Scott introduced another target revolver which was marked on the barrel extension either 'W.S. Army Model' or 'W.S. Target Model'. Both were the same weapon and are usually known under the collective title of 'Bisley Target Revolvers'. They were .455 calibre and very similar to the Government Mark VI, though they used parts from Mark IV, since the Mark VI was still some years away. Barrels were 4 inch, 6 inch or 7½ inch and the usual target sights were fitted.

## MARK IV, 1929

When the Government introduced the .38 Enfield in 1927, the connection with the firm of Webley & Scott ended. Webleys then went into production with their

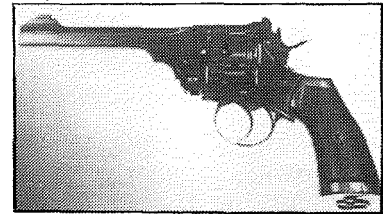

Webley .32 Mk. 4

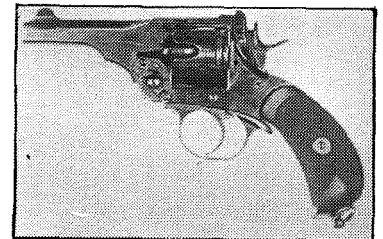

Webley .455 Mk. 5

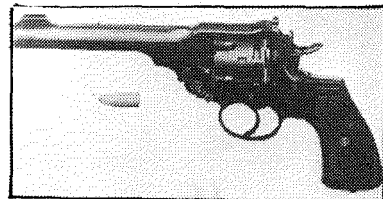

Webley .455 Mk. 6

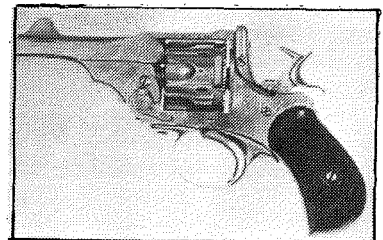

Webley .38 Pocket Mk. 2

own version of the Mark IV .38, and it was on the market by 1929. This revolver was little different from the Enfield .38, which in any case, was no more than an adaptation of the original Webley, so the family likeness was inevitable. It was produced in two barrel lengths, 4 inch and 5 inch, and was widely adopted by police forces. When the Second World War broke out, the War Office placed large orders for the

## FIREARMS

Webley, and it was issued alongside the Enfield, despite the fact that there were minor differences in dimensions which meant that not all spare parts were interchangeable.

### MARK IV TARGET MODELS, 1929-1955

Target versions were made from the beginning of the series, the main differences being in the selection of the mechanism and the fitting of the sights. All target versions had a backsight with a later adjustment. Later, post-war, models have a 6 inch barrel.

### MARK IV .22 TARGET MODEL, 1929-1955

A successful .22 version was produced, which had the same sized cylinder and barrel as the full-bore. This permitted realistic practice shooting without the expenditure of expensive ammunition and it was popular with police forces. The balance is very good and the accuracy excellent. The barrel is 6 inches long, and the cylinder is chambered for the .22 long rifle cartridge.

### MARK IV .32 VERSIONS, 1929

The standard Mark IV was also produced in .32 calibre, the outside dimensions of the weapon being unaltered.

### MARK IV POCKET MODELS

The Mark IV pocket models are little different from those of the Mark III, except that they have the slightly revised mechanism and a holster guide. This latter feature arises from the use of standard components, and it was obviously not worth the expense of removing it. All pocket models have 3 inch barrels and are chambered for .38 or .32. A small number have been made in .22. These pocket models have the same small butt as the Mark III, with the word 'WEBLEY' inset across the top.

### THE WEBLEY-FOSBERY AUTOMATIC REVOLVERS

The introduction of the automatic pistol in the last years of

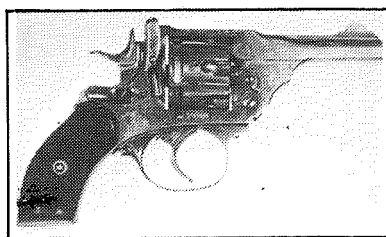

**Webley .32 Pocket Mk. 3 with Safety Catch**

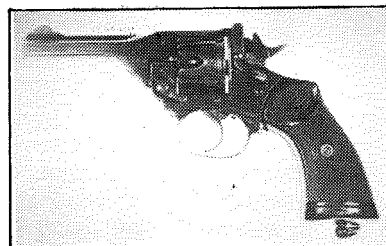

**Webley .455 W&S Army Model**

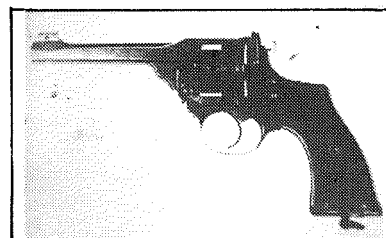

**Webley .22 with Stepped Cylinder**

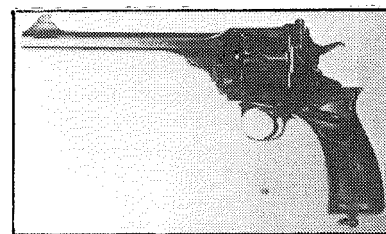

**Webley-Fosbery .455 1901**

the nineteenth century, caused considerable argument as to the relative merits of the revolver against the newcoming. Colonel Vincent Fosbery invented a type of automatic revolver which he claimed combined the virtues of both, and his idea was developed and marketed by the Webley & Scott Revolver & Arms Company Limited. The basis of Colonel Fosbery's invention was the use of the recoil and the cartridge to rotate the cylinder and re-cock the hammer. To do this, he divided the frame into two parts. The upper contained the barrel and cylinder, the lower, was the butt and trigger mechanism. The upper half recoil on a slide, on

the top of the lower, and the cylinder was rotated by means of zig-zag groove cut round its outer surface which engaged with a stud on the fixed lower half. The hammer was knocked back in the movement of the cylinder.

Inevitably, the division of the frame made for a much larger revolver, and the Fosbery's are by no means pocket sized. They are also slightly heavier by about 6 ounces than their contemporaries in the same calibre. However they are all very pleasant to shoot since the majority of the recoil force is absorbed by springs, and the shooter's hand receives a gentler and slower push than with a fixed frame. For this reason, the Fosbery was popular with target shooters and after the First World War, when it was no longer an army issue, it was usually excluded from military competitions on the grounds that it gave the firer an unfair advantage.

Despite the many virtues of the Fosbery, it was never made in quantity. It was more expensive to manufacture, and far less resistant to dirt and dust than the Marks IV, V and VI which were contemporary with it. Once the side jammed the weapon was useless. Manufacture died out with the start of wartime contracts in late 1914 and early 1915.

### **.455 MODEL, 1901**

The first production model used as many parts from the Mark IV as possible, and these include the 6 inch barrel and the sights, the hammer, main spring, and cylinder axis pin. Remaining parts had to be specially made. A safety catch on the left side of the frame locked the two moving parts and held the hammer, whatever position it was in. This catch is a feature of all the Fosberys, and was a necessary safety with such a weapon. It was put to the 'ON' position by a push down with the right thumb. The first version was an ugly hooked shape, but this was changed during development of the first series, and a short flat catch with a checkered top was substituted.

A target model with a 7½ inch barrel was introduced at the same time, and it was fitted with the

•Continued on page 30

# DRIVING UNDER THE INFLUENCE OF DRINK AND DRUGS

## CARBON MONOXIDE

This is a notoriously poisonous gas but is not, of course a drug. However, clinically, carbon monoxide poisoning can closely resemble alcoholic intoxication. The gas may form up to 5-10% of car exhaust gases and may constitute a hazard in a closed car, coming either from a leaky exhaust system of the car itself or being sucked in by heater fan from the exhaust of cars in front in a stationary line of traffic. This reason is sometimes advanced as a cause of apparent intoxication in a driver. However, the presence of carbon monoxide can easily be determined in quite small amounts of blood specimen, provided they are taken within a fairly short time of exposure to the gas. (14) Carbon monoxide poisoning may therefore be a defence to a charge of driving under the influence.

## INTOXICATING LIQUOR OR DRUGS

In England, when a 15(I) of Road Traffic Act 1930 was still in force, it was held that the provision created a single offence and not two offences of (a) driving under the influence of alcohol and (b) driving under the influence of a drug. (15) The essence of the offence was that the driver was in charge of a car when in a state of self-induced incapacity; whether the incapacity had been caused by drink or drugs did not affect the nature of the offence. The words 'under the influence of drink or drugs' were merely adjectival. The elements causative of the incapacity need not have been further identified of one or the other. Similarly the Supreme Court of Canada has held the essence of the offence was driving under a certain condition there being two ways in which the condition might be brought about. The gravamen of

the offence is the impairment of the driving and not the consumption of alcohol. (16) However, judicial notice may be taken of the fact that the effect of alcohol may be different from the effect of a drug and the effect of one drug may differ from another. Anti-convulsants (e.g. Epanutane) can produce side effects including gastro-intestinal upset and disturbance of speech, while anti-histamines e.g. Benadryl, Histofax) may produce drowsiness and disturbed vision. (17) Thus it would be highly desirable for the prosecution to specify by what means the driver has been influenced in his driving conduct.

The social conditions under which alcohol and drugs may be taken by a driver differ. It is lawful to consume alcohol in a hotel amidst convivial company, it is not lawful to inject heroin furtively in a man's public lavatory. The effects and symptoms of taking too much beer and taking marijuana are not identical. For the purpose of sentencing it is not a matter of indifference to the sentencing court whether the offender took alcohol or drugs or which particular drug. The means of rehabilitation or treatment may differ greatly. If the charge does not specify whether the driver was under the influence of a drug or of alcohol the sentencing court is deprived of an essential fact in determining a fair sentence. (18)

### Diabetic Drivers

It has been held that where the evidence shows that the driver is suffering from some mild form of diabetes, is in the habit of taking insulin for the complaint and in taking an excessive amount of insulin, which causes him mental confusion and lands him to drive erratically, even

By  
**Dr FRANCO  
BONDIN LL.D.**

PART 3

though no accident or damage has been caused, he commits the offence of driving with the influence of a drug (23). Similarly in England has been said that if people happen to be in a condition of health that renders them subject to going into a coma, the answer is that they must not drive because they are a danger to the public. (24) If a diabetic driver is liable to an attack which put him into a coma, it follows that a diabetic driver who takes insulin drives at his peril and if he drives so much under the influence of the drug as to be unfit to drive he breaks the law. (25)

Glanville Williams maintains that there are certain technical difficulties to hold that insulin is a drug. (26) Insulin is a substance that is present naturally in the normal body but the diabetic falls to manufacture it in sufficient quantities and therefore needs to have it supplemented from outside. He queries the fact whether such a substance could be termed a drug. A diabetic may sometimes faint not from hypoglycaemia (too little blood sugar) but from hyperglycaemia (too much blood sugar) when he has taken insufficient insulin or excessive sugar or starch. Sugar consumed in food cannot, by any stretch of the imagination, be considered a drug. For the diabetic too much sugar is as bad as too much insulin and it would be absurd to distinguish between the two substances on the ground that a normal person cannot easily take too much sugar on a simple occasion, but equally absurd to hold that sugar is a drug. Moreover hypoglycaemia can be caused in a diabetic by extra exertion, worry or exasperation. It is true that less insulin would counteract the condition; but when the diabetic has taken his normal dose of insulin and trouble occurs because of extra exertion, it seems wrong to blame the insulin.

**TO BE CONTINUED**

IL-PULIZIJA - Lulju-Awissu





From Malta you can dial direct to GREECE (Code No: 030);  
FRANCE (Code No: 033); ITALY (Code No: 039);  
HOLLAND (Code No: 031); BELGIUM (Code No: 032);  
SWITZERLAND (Code No: 041); U.K. (Code No: 044);  
and WEST GERMANY (Code No: 049).

(\*) To save 25% you can phone from Mondays to Saturdays  
from 9 00 p.m. to 8 00 a.m. Sundays ALL DAY

TELEMALTA OFFICES AT PACEVILLE ARE OPENED 24 HOURS A DAY FOR TELEXES - TELEGRAMS - OVERSEAS CALLS

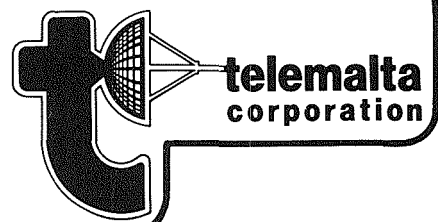

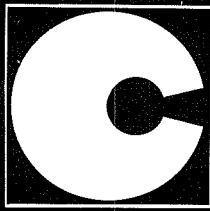

# Chubb

## total security systems

- Safes and Cabinets
- Burglar Alarms
- Fire and Gas Protection
- Electronic Systems

Racall-Chubb Security Systems Ltd.  
*Representatives for Malta and Libya:*

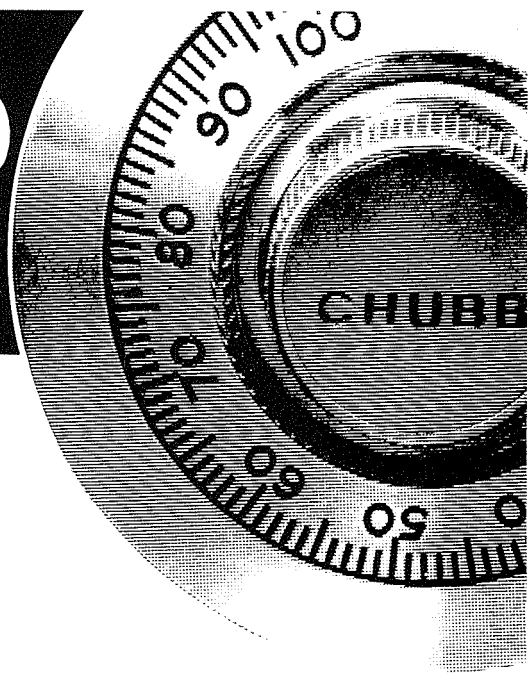

### PHILIP TOLEDO LIMITED

Notabile Road, Mriehel.  
Tel: 444747, 445566, 231312, 491525.



Sole Importers: CAPT. A. CARUANA LTD. VALLETTA. TEL.: 626202-625903

# IL-PULIZIJA U L-EŻERĊIZZI FIZIĊI

•KIF ahna hbieb? Jiddispijaci li fil-harga li għaddiet ma ppubblikajniex l-edizzjoni li kien imiss. Però din id-darba hejjejtlikom sensiela mhux hazin u li wiehed ma għandux għalfejn jiddejjaq. Nahseb li bhali kontu mpenjati b'aktar xogħol u siegħat twal minhabba l-kampanja elettorali, li bhala membri tal-Korp tal-Pulizija jkollna aktar xogħol x'inwettqu. Izda dan huwa xogħolna li jiġi qabel kollox. Minhabba f'hekk, bhali nahseb li wiehed qgħad xi ftit lura mit-tahriġ fiziku tas-soltu. Però ejjew ma nharsux iżjed lura u nibqgħu għaddejnin bil-programm tas-soltu b'xi haġa ġdida wkoll.

Mela biex wiehed jibda, tajjeb li jirrepeti l-eżerċizzji kollha li għaddejna sa issa biex ikun jaf eżatt fejn qiegħed. Min-naħa l-oħra wiehed irid iżomm quddiem għajnejh u joqgħod attent li ma jagħmilx sforz iżżejjed. Għalhekk wiehed irid jagħmel l-eżerċizzji bil-mod tajjeb u kif spjegati.

Peress li issa bdiet is-shana, ċert li hawn min jaqta' qalbu jittrenja, u jippreferi li joqgħod x'imkien għal frisk u jistrieħ. Wiehed irid jifimha li dawn ma' humiex eżerċizzji tax-xitwa biss, u jekk wiehed jgħaraq aktar mis-soltu ma jkun gara xejn. Issa nkunu irġiel. Peress li s-shana għada fl-aħjar tagħha, hemm it-tendenza li kull meta nagħmlu xi wiehed mill-eżerċizzji nagħmluh hazin jew ta' kafkaf biex taparsi nkunu għamilnih. Le, aħjar nagħmlu żewġ eżerċizzji u tajbin milli hafna u hżiena.

1) Mela nigu għall-ewwel eżerċizzju ġdid. Sintendi dan nipruvawh wara li tagħmlu xi haġa mill-oħrajn ukoll.

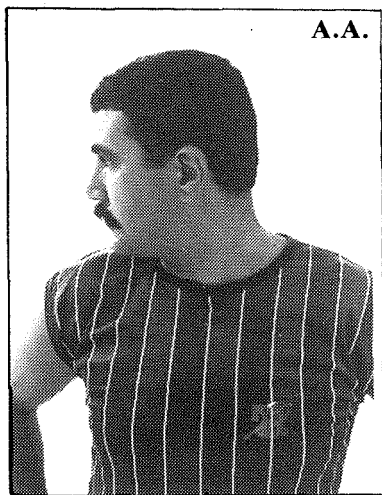

**Neck Rotation:** Hekk insibuh dan l-eżerċizzju. Kull ma wiehed irid jagħmel huwa li joqgħod dritt sewwa u bil-mod ibda dawwar rasek lejn il-lemin sakemm tista', wara lejn ix-xellug kemm tista'. Oqgħod attent li

## MILL-ISPETTUR RAYMOND ZAMMIT

meta ddu ma' ddawarx is-sider, Wara bl-istess pożizzjoni mejjel rasek l-isfel kemm tista', wara tella rasek kemm tista'. Għal darb'oħra wiehed ma' jridx li jintlewa mill-qadd. Irrepetu għal lanqas hames darbiet. Hemm iċ-ċans li f'dan l-eżerċizzju wiehed jistordi xi ftit, peress ma jkunx għamel dan l-eżerċizzju qabel. Dan l-eżerċizzju tajjeb hafna għall-ghonq. Fig A.A.

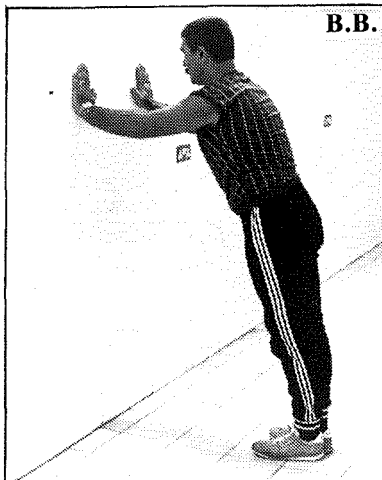

2) It-tieni eżerċizzju għal din l-edizzjoni insibuh bhala 'WALL PUSH UP'. Dan l-eżerċizzju huwa s-sigriet li Richard Dubois, darba Mr. America kien jinkoraggixxi biex wiehed jiffirma dirghajn sbieħ u b'saħħithom. Kull ma wiehed irid jagħmel huwa li joqgħod dritt mal-hajt kif muri Fig B.B. Ressaq saqajk lura sakemm il-piż ta' gismek jiġi kollu fuq dirghajk. Issa pressa l-piż ta' gismek kollu 'l bogħod mill-hajt, u jirnexxilek tagħmel dan billi tistira ringlejk u tidritthom sewwa. Immedjatement wara erga' għal pożizzjoni li tkun. Irrepeti dan l-eżerċizzju għal tliet darbiet u pprova għamel (reps) kemm tiflah biss minghajr sfurzar żejjed. F'dan l-eżerċizzju

tistrieħ aktar minn (30 sec.) bejn set u iehor. Wara ftit li tkunu għamiltu ftit minn dawn l-eżerċizzji, wiehed ikun jista' jinnota moviment fil-muskoli ta' l-idejn. Tinsewx hbieb, kulu sewwa, ixorbu ftit halib u żgur li tiksbu r-riżultati mixtieqa.

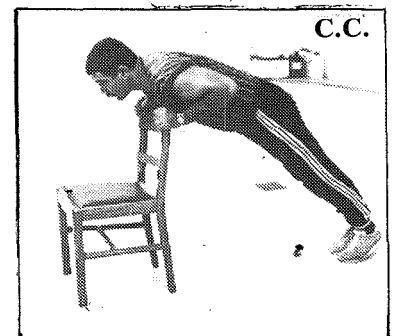
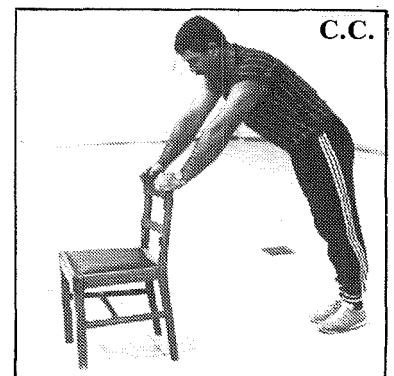

3) It-tielet eżerċizzju huwa dak li nsibuh bhala 'CHAIR TRICEPS PUSHUP'. Kull ma wiehed għandu bżonn għal dan l-eżerċizzju huwa siggu wiehed. Ma ninsewx hbieb, bhal ma diġa għedna drabi oħra, qisu li s-siggu li tagħažlu jkun sod. Oqgħodu fil-pożizzjoni murija Fig C.C. L-idejn iridu jkunu bejn wiehed u iehor (20 cm) imbegħdin minn xulxin. Li jmiss huwa li wiehed irid iżomm il-minkbejn kemm jista' jkun il-gewwa mal-qadd u bil-mod il-mod ibdew neżlin 'l isfel b'ritmu sod sakemm is-sider imiss il-pali ta' l-idejn jew aħjar dahar is-siggu wżat. Irrepetu dan għal darbtejn b'għaxar (reps) kull darba.

# IL-PULIZIJA U L-EŻERĊIZZI FIZIĊI

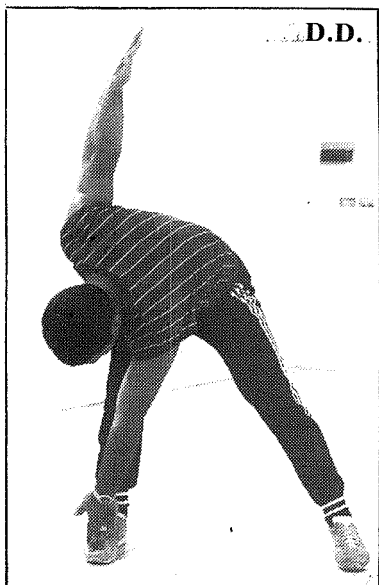

4) Eżerċizzju iehor għal din id-darba huwa dan li ġej u li nsibuh bħala 'WINDMILL TOE TOUCHING' li jidher Fig D.D. Dan huwa eżerċizzju hafif hafna, però wiehed irid jagħmlu tajjeb biex jakkwista dak kollu tajjeb minnu. Li wiehed irid jagħmel huwa li jpoġġi l-parti ta' ġismu 'l fuq, voldieri mill-qadd 'il fuq parallel ma' l-art, dirgħajn stirati, saqajn impoġġija bejn wiehed u iehor (40cm) 'il bogħod minn xulxin. Issa kull ma trid tagħmel ipprova miss is-siba l-kbir ta' kull sieq bil-pala ta' l-id, mentri bl-id l-oħra tkun 'il fuq. Biex tmiss is-sieq l-oħra sintendi ddawwar l-idejn. Ma' ninsewx is-saqajn iridu jibqgħu dritti kemm jista' jkun. Għamel dan l-eżerċizzju għal xi minuta jew qrib jew sakemm thossok qieghed tghejja. Set wiehed min dawn ikun bizzejjed.

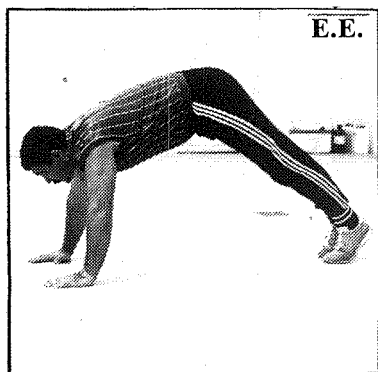

5) L-eżerċizzju li jmiss insejhu **JACKNIFE DIP**. Dan l-eżerċizzju huwa iehor min sensiela ta' push ups. Kull ma trid tagħmel huwa, poġġi kif jidher Fig E.E. Kun ċert li l-warrani qieghed 'il fuq kemm tista'. Meta tkun hekk, ikkonċentra hafna fuq ir-ras li ha tipprowa tmissa ma' l-art u dan tkunu tistgħu tagħmluh billi tilwu d-dirgħajn Konċentrament ukoll fuq id-dirgħajn irid ikun aktar milli fuq is-sider. Meta tagħmel hekk, ipprova li l-'Jacknife position' iżzomm tajjeb. Minn dawn għamlu tliet sets ta' għaxar sets kull darba.

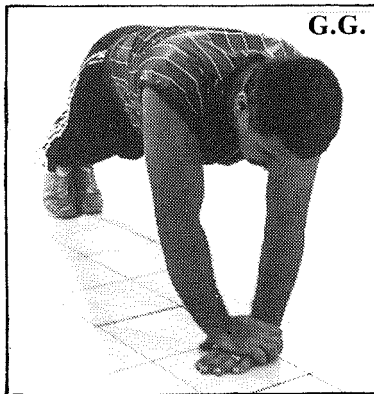
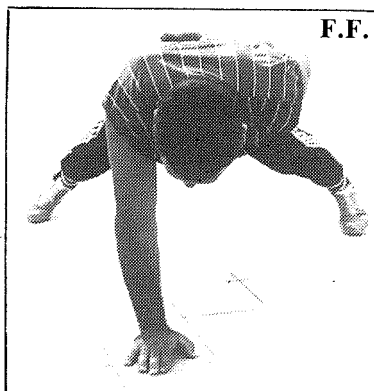

6) **ONE ARM PUSHUP** huwa l-eżerċizzju l-iehor li sejjer ngħaddilkom biex tipprowaw. Agħtu titwila lejn Fig. F.F. Poġġi id waħda bil-pala miftuħa thares dritt il-barra. L-id l-oħra trid tkun wara d-dahar, sakemm thossok qieghed tghejja u n-nifs beda jnaqqas. Strieh ftit (2 min) u erga' pprova.

Biex wiehed jgħinkom thejju għal dan l-eżerċizzju, tajjeb li wiehed iħares lejn l-eżerċizzju li jidher Fig G.G. Dan nagħmluh billi npoġġu saqajna ma' xulxin,

idejna waħda fuq l-oħra b'ta fuq taqbad il-polz ta' l-id ta' taħt, noqghodu dritti kemm jista' jkun u nitilgħu u ninzlu. Ma' ninsewx meta nkunu isfel inharsu 'l quddiem.

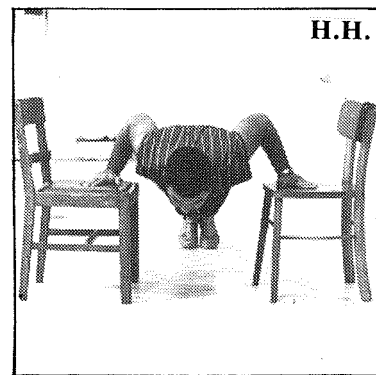
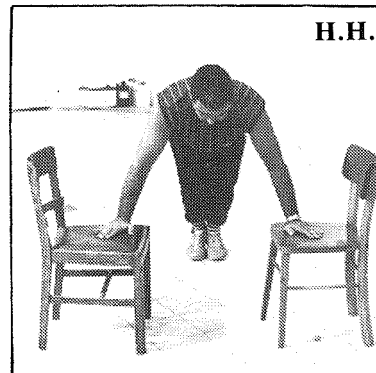

7) L-aħhar eżerċizzju għal din id-darba huwa dak li nsibuh bħala 'WIDE GRIP CHAIR PUSHUP'. Dan l-eżerċizzju jgħin hafna biex niżviluppaw aktar 'il biċċa ta' fuq tas-sider.

Kull ma' wiehed għandu bżonn din id-darba huma żewġ sigġijiet: l-ewwel

a) Poġġu is-sigġijiet wiċċ ma' wiċċ imbegħdin bejn wiehed u iehor (65cm);

b) Poġġu jdejkom fuq is-sigġijiet bil-pali jħarsu 'l quddiem;

c) Inzlu billi tagħwgu jdejkom sakemm is-sider ma' jkunx jista' jinzel iżjed;

d) Wara ergħu itilgħu għal pożizzjoni li kontu bil-mod biex la niehdu skossi u lanqas inweggħu. Għamlu dan għal tliet darbiet wara xulxin u għamlu mill-inqas tmien sets. Ħarsu lejn Fig H.H.

Mela dawk kienu l-eżerċizzji godda li għaddejnilkom f'din l-edizzjoni. Tinsewx hbieb, it-trenjaw tajjeb u kulu tajjeb.

Issa sejrin nagħddu għal xi haġa oħra li wiehed jista' jistaqsi

## IL-PULIZIJA U L-EŻERĊIZZI FIZIĊI

u forsi ma jsibx risposta kif jix-tieq. Niltaqa' ma' hafna hbieb speċjalment ta' età mezzana li jistaqsuni kif sejjer jirnexxilna in-nehhu l-piż żejjed. Nibdew mela għal dawk li għandhom din il-problema.

1) Kull min huwa normali u fiżikament b'saħta jista' jitlef il-hxuna jew piż żejjed.

2) Ovvjament biex figura titlef il-piż huwa billi tkun qegħda tiġi mitmugħa inqas mis-soltu.

3) Billi wieħed jagħmel daqsxejn ta' saġrificju u jibda jinterressa ruħu f'xi eżerċizzju halli b'hekk dejjem inkunu qegħdin insaħħu l-muskoli. Issa, jekk wieħed ikun 'overweight' l-ewwel

### Well and Bravely Done, S.M.U.

From Commander to  
General,

I would like to commend the gallant brave action of S.M.U. members constables P.C. 1010 Emmanuel Vassallo and P.C. 995 Stephen Falzon, who on Sunday 16th August 1987, while returning to Malta after a strenuous day of duty at Gozo on board the M.V. Mellitaland at night, jumped into the sea at Cirkewwa to save the life of Joseph Sammut, aged 25 of Qormi, who fell overboard and was about to be crushed between the ship and the quay.

They disregarded the present danger of loss of their lives and limbs to save another human being. In their courageous endeavour they were ably assisted by all the other members of S.M.U. who formed a human chain to rescue the unfortunate man.

Once more, S.M.U. have proved themselves the elite of the Corps.

ma' għandu jagħmel hu li jara anke permezz ta' Tabib u jara kemm il-libra jrid jew aħjar jentieg li jnaqqas. Kultant issib nies li jkollhom dik id-daqsxejn ta nefha mad-dawra tal-qadd u l-istess dawn għal raguni jew oħra jaqtgħu qalbhom biex in-nehhuha. F'kelma waħda trid tiddeċiedi x'sejjer tagħmel u jekk tasalx. Biss min-naħa l-oħra, jien ngħidilkom li ma' hemmx f'wieħed għandu jaqta' qalbu. Li trid tkun żgur huwa li ma tkunx sodisfatt jekk ma tnehhix sa' lanqas libra żejda minn fuqek. Jekk wieħed ikun oħxon iżżejjed u jkollu b'żonn ta' xi dijeta jien nirrakkomanda li qabel jibda xi taħriġ fiżiku jikkonsulta mat-Tabib tiegħu u jgħidlu bil-pjan li jkun sejjer iwettaq.

Mela meta wieħed jiġi biex jibda, l-ewwel haġa li għandu jagħmel huwa li jintizen sewwa, u jżomm il-gurnata u l-piż eżatti. Dan jiswiegħ 'l quddiem Permezz ta' Diary nizzel sewwa u eżatt xi tkun kilt mal-gurnata. Hawnekk tidhaqx bik innifsek - għalkemm kultant b'dak li tkun nizzilt tibqa' skantat u tkun xi haġa tad-daħk. Nizzel kolloxx, tē, kafē, zokkor, cake, helu u dak kollu li jirnexxilek titfa' gewwa l-istonku tiegħek mal-gurnata min fil-ghodu sa fil-għaxija sakemm tiġi biex torqod. Wara li tkun għamilt dan naturalment - pprova aqta' dawk l-affarijiet l-aktar li jħaxxnu. Eżempju ta' dan l-ewwel gimgha tista' tnaqqas iz-zokkor kollu min mat-tē jew kafē. Żgur li permezz ta' dan tkun neħhejt xi ftit tal-piż.

Il-gimgha ta' wara pprova tiekolk patata, haġa li hawn Malta ta kuljum insibuha fuq il-mejda ma' kwalunkwe ikel. Tiekol xejn minna. Il-gimgha ta' wara kemm jista' jkun illimita fil-hobz. Naqqas kemm tista'. Tnaqqis għandu jkun ukoll fil-birer, gallettini, għagin. Issa speċjalment li qegħdin fix-xhur tas-Sajf, il-gelati u affarijiet oħra simili. Pprova kul minflok dawn l-affarijiet li qtajt, hxejjex u frott frisk. M'għandniex xi ngħidu li taqta' kolloxx f'daqqa huwa impossibbli, però wieħed għandu jżomm f'moħħu kemm wara sejjer jiswielu. B'dan il-mod, voldieri tnaqqis ta' certu ikel u ftit eżerċizzji fiżiċi jgħinuk ikollok muskoli aħjar, nifs u energija aħjar u mingħajr tbatija u cert li

tkun tidher aħjar f'dik li hija persuna.

Biex jirnexxilek tagħmel dan toqgħodx taqta' qalbek jew inkella tagħti widen għal xi hadd li jista' jaqtgħalek qalbek, iżda if-faċja din il-għieda personali b'ambizzjoni u insa il-passat. F'moħħok zomm li xi darba sejjer tkun dak li dejjem xtaqt li tkun u tidher.

Min gimgha għal gimgha oqgħod attent għal progress li tkun qiegħed tagħmel u erga' intizen u rabbi kuragg iżjed. Mhux sempliċi, però m'hemm xejn gdid. Ara ma jkunx hemm xi hadd u jahseb li rrid nagħmel il-mirakli jew l-impossibbli miegħu, iżda wieħed irid iddahal f'moħħu li dan huwa sempliċement inkor-raggiment u min-naħa tagħkom dan hu naqra kuragg u saġrificċju.

Meta jirnexxilkom tagħmlu dan u taraw li qegħdin ikollok aktar nifs pprovaw xi eżerċizzju min dawn li għaddejnilkom. Għal dawk li tkellimna fuqhom u li għandhom hxuna żejda, dawn li gejjin huma xi ftit ta' 'Tips' x'wieħed għandu jagħmel:

1) Torqodx żejjed - tmien siegħat huma ftit iżjed minn bizzżejjed.

2) Tintelaqx, speċjalment wara l-ikel. Mixja żghira tagħmel taj-jeb.

3) Imxi regolarment u pass daqsxejn mgħaġġel.

4) Toqgħodx tinkwieta jekk qiegħed tnaqqas mill-ikel biex tneħhi l-hxuna żejda, jibda jkollok xi tgergir fl-istonku.

5) Kun onest fl-ikel. Tgħidx ha-nzid ftit u nnaqsu l-ghada.

6) Ipprova imxi mal-programm - gurnata b'gurnata.

7) Tistenniex mirakli kbar mill-ewwel.

8) Tistenniex li sejjer tonqos kull gimgha. Tnaqqis jibda jkun hafna iżjed differenti u inqas kull gimgha.

9) Kul bil-mod - jekk ma' tafx tagħmel dan qatta l-ikel biċċiet żghar.

10) Ipprepara ruħek għax jaf ikollok xi daqsxejn ta' dipressjoni. F'każ li jkun hekk dan jgħaddi malajr.

Kuragg hbieb. Ktib daqsxejn fit-tul biex inlahqu mal-programm u biex min-naħa tagħkom ma tieqfux.

# DEFAMATORY LIBEL AND THE PLEA OF "FAIR COMMENT"

If the truth of the matters is substantially proved, the defendant is not liable to punishment if the court is satisfied that the proof of the truth has been for the public benefit.

To what extent and in what way does the plea of justification differ from that of "fair comment"? A clear distinction was put forward by W. Valentine Ball (5) who held that, "a defendant who pleads fair comment ... is entitled and bound to prove the truth of the facts on which his comment is based, even if such facts in themselves convey inferences defamatory of the plaintiff. But where the libel itself contains defamatory allegations of facts as well as comments, a plea of fair comment alone will not protect such allegations; the defendant will be entitled to prove the facts as the basis of his comments, but he will have no defence so far as the allegations of facts are in the themselves defamatory, unless he has also pleaded justification in the strict sense, or some other defence, such as "privilege". What is the position under Maltese law? This point was analysed in re: **Prof. Dr. V. Griffiths et. vs. G. Micallef et.** decided by the Court of Criminal Appeal on the 30th March 1978 per F. Mizzi, J. The position was stated as follows:

"Fis-sistema legali Ingliż – salva f'kull każ il-htieġa li tigi pruvata l-verità tal-fatti disputati – mhux dejjem jehtieg li d-difiza tal-'fair comment' tinghata unikament ma' dik tal-'justification'...

"Fl-ambitu tal-ligi tagħna, in-vece, l-artikolu 12 tal-Att dwar l-Istampa jiddisponi bl-aktar mod kategoriku u mingħajr ebda distinzjoni ta' xejn li l-prova tal-verità tal-fatti attribwiti f'kull kawża ta' libell minħabba malafama hija amessa biss fil-każi hemmhekk tassativament indikati u jekk l-akkużat, fl-istadju

By

**The Hon. Mr. Justice  
JOSEPH A. FILLETTI  
B.A., LL.D.,**

## Part 2

preliminari tal-kawża, jassumi l-piena responsabilità ta' malafama lilu imputata u jiddikjara, b'difiza tiegħu, li jrid jipprova l-verità ta' dawk il-fatti. Konsegwentement, fis-sistema patriju, id-difiza tal-'fair comment', in kwantu timplika n-necessità li tigi pruvata l-verità tal-fatti kontestati, mhix konċepibbli, bla ma jigi traxendat is-sinjifikat manifest tal-ligi, jekk mhux konguntament ma' dik tal-verità tal-konviċju, li permezz tagħha biss, meta tkun sollevabbli, jista' jinfetaħ l-aditu għar-riċerka ta' dik il-verità...".

This judgement seems to narrow appreciably the basic differences between the two pleas as far as Maltese law is concerned. A solution to this apparent anomaly lies in an analysis of the alleged defamatory statement. If the statement is based on allegations of facts, then it is obvious that the plea to the raised must necessarily be that of justification. If, on the other hand, the libel proceedings are concerned only with comments, then the plea of fair comment can be raised. This line of teaching emerges from a number of judgements delivered by our courts. In are: **Il-Pulizija vs Nestu Laiviera**, Court of Appeal per W. Harding, J. (Koll. XXVII-IV-1968) it was held that,

"Huwa essenzjali, qabel xejn, li jigi determinat jekk l-espressjonijiet ... kienux kummenti jew allegazzjonijiet ta' fatt: għax jekk huma allegazzjonijiet ta' fatt, allura ma hemmx kwistjoni tad-

difiza tal-'fair-comment', għar-raġuni li għal 'statement of fact' id-difiza hi dik tal-verità jew ta' 'privilege'."

In the judgement above quoted, the learned judge then very succinctly touched upon the question of what amounts to a fair comment, stating that,

"It-'test of fairness', kif wiehed jista' jara minn eżami tad-dottrina u l-gurisprudenza Ingliża in materja, hu jekk dawk l-espressjonijiet humiex 'a reasonable inference from the facts' li kien jagħmel 'a fair-minded man'. Minn jiggudika ma hemmx bżonn li jaqbel ma' dak il-komment; jista' ma jaqbilx, imma jehtieg li l-komment ikun tali li bniedem 'with a fair mind' jista' jagħmlu (ara *inter alia*, **Button, Libel and Slander**, 2nd edition, p. 94). Is-sempliċi esagerazzjoni, anke jekk kbira ('gross'), ma tnehhix, għalhekk biss, id-difiza tal-'fair comment' (ara **Merivale v. Carson** per Lord Esher, 1887, 20 Q.B.D. 275. p. 280). Esagerat jew le, però, malli l-'comment' jissorpassa l-limiti ta' 'fair criticism', allura l-kliem isiru libellużi (ara **Campbell v. Spottiswoods**, 1863, 32 L.J., Q.B. 185, per Mellor J.).

In re: **D. Mintoff vs. T. Hedley et noe.** decided by the same court on the 28th November, 1953, reference was made to a foreign judgement, namely **Joynt v Cycle Trade Publishing Co.** (1904), 2, K.B., 292, p. 262, per Kennedy J., wherein it was held that, the comment must be such that a fair mind would use under the circumstances, and it must not mistate facts, because a comment cannot be fair which is built on facts which are not truly stated.

(To be continued)

### SOURCES OF REFERENCE:

5. *vide judgement delivered by C.J.P. (Criminal Court) delivered on 24.8.82.*



# PEUGEOT



# TALBOT



### PEUGOET 205 SALOON

- 11 models to choose from
- 7 models, 5 doors – Petrol and Diesel
- 4 models, 3 doors – Petrol and Diesel
- Four petrol engines – 954cc – 1124cc – 1360cc and 1580cc
- Diesel engine 1769cc
- 4 speed synchromesh gearbox on XE & XL, GE & GL models
- 5 speed synchromesh gearbox on XLD, XR, GLD, GR, GRD, GT and GT1 models available
- electronics ignitions on petrol engined models
- Very low fuel consumption on all models.

### TALBOT HORIZON LS



- 1294cc petrol engine
- 5-speed synchromesh gearbox
- Push button radio
- Available from stock
- Very economical



### PEUGEOT 305 SALOON

- 7 models to choose from
- All models – four door saloons
- three petrol engines – 1290cc – 1580cc – 1905cc
- Diesel engine 1769cc
- 4-speed synchromesh gearbox on GR 1290cc and automatic
- 5-speed synchromesh gearbox on GR 1600cc, Sr, GT, GTX, GLD and SRD models
- Electronic ignition on petrol engined models
- Estate models also available.

### PEUGEOT 505

- Luxurious and elegant
- 6 Saloon models
- Estate models
- Choice of 1971cc petrol engines and 2498cc diesel and turbo charged diesel engines.
- Soon available from stock.

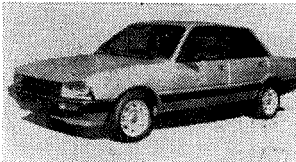

PEUGEOT



TALBOT

CONCESSIONAIRES

### MICHAEL ATTARD LTD.

NATIONAL ROAD, BLATA L-BAJDA, MALTA

TEL: 228854 – 221951

Gozo Sub-Agents: MESSRS. PARDI MOTORS LTD.

REPUBLIC STREET, VICTORIA, GOZO – TEL: 556678

## Saer WATER PUMPS

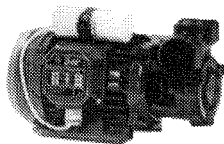

## STUART PUMPS

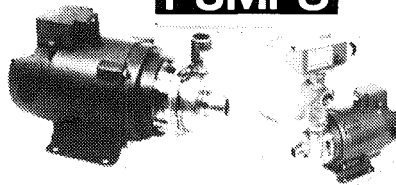

## WET WOODWORKING MACHINES

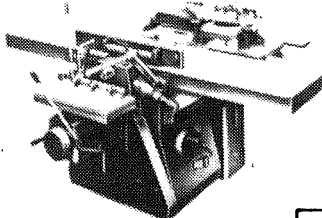

## MEBER BAND-SAWS

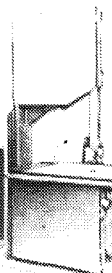

## MiniMax

The complete and compact woodworking machine

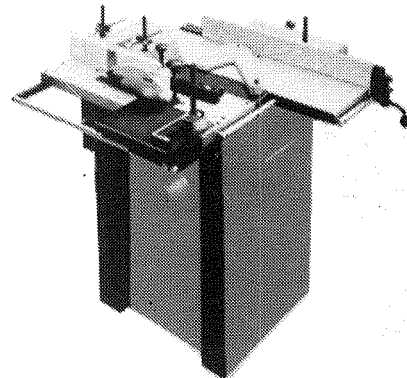

## V. Demajo Bros.

Electrical and Mechanical Division  
8/9 Valletta Road, Paola. Tel: 234502



COGNAC  
**COURVOISIER**  
*Le Cognac de Napoleon*

Exclusive representatives **WANDS** Limited — A **FARSONS** Subsidiary. Tel: 232121

*Jwyfords Bathrooms*  
The Best of British.



99 National Road, Blata L-Bajda Tel: 234405, 623485  
118A Paola Hill, Paola. Tel: 804258, 805035  
18 Constitution Street, Mosta Tel: 495889



# Lehen l-Ghaqda tal-Pulizija Pensjonanti

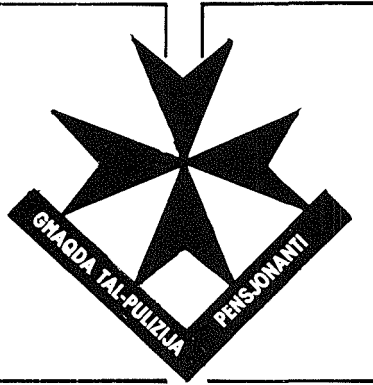

IS-SUR SALV FAVA

## INTERVISTA MA' EX-P.S. 268

Fl-4 ta' Awissu, 1987, l-Ghaqda tal-Pulizija Pensjonanti kompliet bis-solitu intervisti ma' whud mill-Membri Anzjani taghha, u din id-darba marru fid-dar tal-Ex-Surgent tal-Pulizija Nru. 268 Salvu Fava, f'Rinella Street, il-Kalkara, li illum ghandu 78 sena, u hemmhekk il-Membru taghna rrakkonta xi ftit mill-esperjenzi tieghu meta kien iservi fil-Korp tal-Pulizija, x'kontribut ta lis-Servizz u semma wkoll certti attivitajiet straordinarji li ha sehem fihom huwa.

Is-Surgent Fava beda biex qal li huwa ilu madwar 30 sena irirat. Qabel ma dahal fil-Korp tal-Pulizija huwa kien impjegat ma' zijuh, is-Sur Gauci Borda li kellu hanut fil-Kalkara; meta ghalaq it-18 il-sena, fl-1930, Salvu gietu xewqa li jidhol bhala Kuntistabbli fil-Korp tal-Pulizija. F'dak iz-zmien li ngagga fis-Servizz, il-Kummissarju kien is-Sur Salvu Galea.

*Domanda: "Fejn servejt fil-bidu tal-karriera tieghek fil-Korp?"*

Salvu Fava: "Niftakar li ghall-bidu kienu baghtuni ghassa ma' certu prigunier Bajada li kien pazjent fl-Isptar Centrali, il-Furjana."

*Domanda: "Id-Depot fejn kien dik il-habta, kontu taghmlu xi kors?"*

Twegiba: "Id-Depot kien innaha t'isfel fi Triq Merkanti, il-Bel, hdejn il-Kamerata, illum il-

# Saviour Fava

bini tač-Centru tal-Mediterran għall-Kongressi. Kif dhalt, flimkien ma' Pulizija oħra, konna naghmlu "Physical Training" u drill, kien ikollna l-"lectures" fuq diversi sugġetti, ligijiet u regolamenti li jappartienu l-Korp, u kienu anke johorguna naghmlu ghassa fuq il-"Beats" tal-Belt. Konna nohorgu nimmarċjaw wara l-"fall-in" madwar ghoxrin Kuntistabbli f'daqqa u konna nimpostjaw ruhna fil-kantunieri tat-triqat principali tal-Belt "fixed point duty".

*Domanda: "Fejn gejt trasferit wara l-Belt?"*

Twegiba: "Mill-Belt, mort il-Furjana, u kif semmejt ftit qabel, ghamilt xi zmien ghassa ma' Bajada tal-Hamrun, li kien akkuzat bl-omicidju ta' martu; kont jien flimkien ma' ex-P.C. 478 Guzeppi Maria Pace. Spettur il-Furjana dik il-habta kien is-Sur Frank E. Tonna Barthet".

*Domanda: "Kellek xi haġa partikolari li tiftakar li ghaddejt minna int?"*

Twegiba: "Ftit taz-zmien wara li kont il-Furjana, jiena gejt trasferit ghas-C.I.D., u ghal habta tat-Tieni Gwerra Dinjija, kont sekondat mad-Defence Security Office, li kienet tifforma parti speċjali tas-Servizz Inġliż gewwa Malta. Wahda mill-missjonijiet li kont involut fiha, kienet bla dubju ta' xejn iż-zjara f'Malta tal-Prim Ministru Inġliż, Sir Winston Churchill. Kont



Ex P.S. Fava jiskorta lil Sir Winston waqt li kien hiereġ mid-Dockyard Main Gate, Senglea huwa u sejjer għall-Konferenza ta' Yalta. - 1943.



## INTERVISTA MA' EX-P.S. 268 SAVIOUR FAVA

dettaljat mid-Defence Security Officer biex niehu hsieb il-Prim Ministru Ingliz waqt zjara li għamel fit-Tarzna ta' l-Ammiraljat u sabiex nara li ma jinqala' ebda incident. Kollox mexa harir, u l-haddiema kollha laqghu lil Churchill b'entuzjażmu kbir." L-ex-Surgent Fava kellu l-okkazjon: li jipprezenta ritratt fejn juri fost l-ohrajn lil Sir Winston Churchill, l-Ammiral McKenzie u Uffiċjali Għolja tas-Servizz Ingliz, segwiti minnu (Ritratt f'pagna 15)

Apparti z-zjara ta' Churchill, is-Sur Salvu Fava qal li kellu l-istess biċċa xogħol meta l-President ta' l-Istati Uniti ta' l-Amerika, Franklin Roosevelt gie Malta abbord "Cruiser" Amerikana, li sorgiet Parlatorio Wharf, u flimkien mad-Defence Security Officer, marru sabiex jilqgħu lill-President. Ikompli jghid l-ex-Surgent Fava: "Il-President Roosevelt kellu 'gangway' speċjali biex ikun jista' jinzel bil-karozza minn fuq il-bastiment; peress li d-Defence Security Officer kellu l-uniformi tas-Servizz huwa tħalla jitle' abbord mingħajr tfixkil izda jiena kont pajżan u bla ma naf kif, sibtu ruħi fi "crash" ma' whud mill-haddiema tat-tarzna f'dawk l-inhawwi, meta xi nofs tuzzana rġiel qishom manigoldi nizzlu minn fuq il-"Cruiser", u li wara sirt naf li kienu tal-F.B.I., mexxewna tul Canteen Wharf sa hdejn il-mina, jidhirli li hija Corradino Tunnel, u ma hallew lil hadd jersaq vicin il-bastiment. Ftit tal-hin wara, jiena rajt lid-D.S.O. jagħmilli sinjal biex nersaq 'il quddiem u hallewni nitla' fuq il-"Cruiser". Dan kien meta l-mexxejja ta' l-Erba' Pajjizi Kbar, cioè l-Ingilterra, l-Amerika, Franza u r-Russja, kienu sejrjn jiltaqgħu għall-Konferenza ta' Yalta".

## APPELL

### Għall-attenzjoni tal-Pulizija Pensjonanti u tal-Membri tal-Korp

•Il-Kummissjoni Morda qed tressaq dan l-appell għall-generosità tagħkom biex tinghata l-għajjnuna lil wiehed mill-pensjonanti tal-pulizija, li fi ftit ġimgħat ohra sejjer jagħmel operazzjoni skabruza f'għajnejh peress li qed jitlef id-dawl.

Ahna nheggu biex titqajjem kuxjenza fostna li f'kazijiet bħal dawn għandna nkunu generuzi u noffru skond il-possibiltajiet tagħna.

Kull offerta li tinghata hija apprezzata. Kull donazzjoni għandha tintbagħat fil-Police Library, Police HQs, Floriana.

**KUMMISSJONI MORDA**

*Domanda: "Tista' tghidilna xi haġa ohra ta' importanza li grat fi żmien il-gwerra, jġigfieri fit-Tieni Gwerra Dinjija?"*

Twegiba: "Jiena irrid insemmi fatt li kont involut fih direttament jiena stess. Dan mhux smajtu jew qrajtu, anzi nibza' li qatt ma għadu nkiteb fuqu minn xi hadd; kien hemm żmien meta l-Isla kienet totalment imblukkata bil-gebel tas-swar u bini mwaqqa', u ma kontx tista' tidhol jew tohrog mill-Mina ewlenija għal Bormla. Dik il-habta, l-Arcipriet Brincat sqarr li n-nies li kienu baqgħu fl-Air Raid Shelters, taħt il-blat fil-qalba ta' l-Isla, kienu verament se jmutu bil-guħ kaġun ta' nuqqas ta' provvisti essenzjali ta' l-ikel. Bħala Protection Officer tad-Distrett kien hemm it-Tabib Pawlu Boffa li ried jevakwa lill-kumplement tar-residenti li baqgħu f'dik il-Belt. Jiena kont wiehed li meta fehemtu u tajtu raġunijiet sodisfacenti biex dawk il-ftit mijiet ta' Sengleani jithallew jagħzlu huma fejn joqogħdu, it-Tabib Boffa hadni quddiem Mr Cohen li kellu l-Uffiċċju tiegħu fil-Kwartieri Ġenerali tal-Pulizija, Fleur-de-Lys, u wara li spjegajtu kollox ġejt fdat biex is-sitwazzjoni prekarja tan-nies ta' l-Isla f'dawk il-jiem ta' l-Assedju fl-eqqel tal-gwerra, nehodha f'idejja. Jiena hawn tlabt provvista ta' zokkor, u hobz għal dawn il-ftit nies. Dawn l-oggetti kont ingibhom l-Isla minn naħa tad-Dwana permezz tad-dgħajjes, u l-barklori kont inħallashom jiena wkoll, lira għal kull vjaġġ li jagħmlu. L-anzjani ta' l-Isla

jiftakru dan meta, min seta' jhallas, kien jixhet fil-kaxxa 3d (1c3) ta' hobza. Jiena wkoll hadt hsieb it-tqassim tar-Ration għar-rigward ta' l-Isla u dan apparti ix-xogħol tiegħi bħala Acting Sergeant".

*Domanda: "Kont involut f'xi haġa ohra, minbarra dik ta' l-Isla"?*

Twegiba: "Iva. Kien il-każ ta' Sedizzjoni meta f'Malta bdiet titqassam ċertu letteratura minn xi nies mhux magħrufa, li l-Gvern Ingliz kien qed iqisha sedizzjuza. Kienu anke ġew xi pulizija minn Scotland Yard (Special Branch) biex jinvestigaw l-affari u niftakar li d-Defence Security Officer kien baġat għaliya, meta kont għadni "attached" miegħu, u wrieni xi ittri kollha propagan-da kontra l-Ingilterra, u qalli li l-Pulizija u s-C.I.D. ta' Malta kienu nformati wkoll, b'dak li kien qed jġiri. Bħala referenza tani waħda minn dawn l-ittri li kienu qed jircievu diversi nies. Intant, għadda ftit taz-żmien u darba nzertajt kont għand wiehed li kien impjegat ma' stamperija u li kien joqgħod Haż-Zabbar, u fuq l-iskrivanija tiegħu osservajt karti u envelopsijiet li kienu jixbhu ferm dawk l-ittri li kien urieni d-D.S.O. Bil-moħbi gbart wiehed minn dawn l-envelopes li kellu l-kaligrafija taqbel hafna ma' dik li kelli jiena, u immed-jatament infurmajt lid-D.S.O. Aktar tard, uffiċjali għolja militari ġewwa Kastilja, fejn hadni d-D.S.O. dak il-lejl, wara li inves-tigaw aktar il-każ, qaluli li fuq l-informazzjoni li tajthom, irnex-xielhom isolvu l-każ ta' l-ittri sedizzjuzi, u saħansitra irrik-

**Lehen  
l-Ghaqda  
tal-Pulizija  
Pensjonanti**



## INTERVISTA MA' EX-P.S. 268 SAVIOUR FAVA

kmandawni ma' l-War Office. Biss jiddispaċini nirrimarka li ma qlajtx 'prosit' minn għand il-Kummissarju tal-Pulizija ta' dak iż-żmien, anzi kliek hażin iddub-bajt għax ma kontx tajt il-każ lilu dirett. Veru li wara jiena ġejt ikkonfermat bhala Third Class Police Sergeant."

Mistoqsi biex jgħid xi haġa fuq il-paga tiegħu meta kien "attached" mad-D.S.O., l-ex Surgent Fava rrakkonta li darba, waqt diskussjoni nfurmali ma' Major Harrow, dan urieh "File" fejn il-War Office kien jirrifondi l-flus tas-salarju tiegħu lill-Kaxxier tal-Pulizija. Meta ra l-figuri fil-"File", is-Surgent Fava rrimarka li ma kienx qiegħed jirċievi dak l-ammont kollu u għalhekk għamel "complaint". Eventwalment sab li kienu qegħdin jaħdmulu paga hażina u kellhom jirrifondulu mal-£200.

*Domanda: "Meta spiċċajt mill-Pulizija hdimt .xi mkien iehor?"*

Twegiba: "Mort għamilt xi żmien bhala Security Officer fil-Fabbrika tas-Sigaretta ta' Wills, Barriera Wharf, ix-Xatt tal-Belt. Domt madwar 16-il sena u fil-fatt anke ġejt intitolat għal pensjoni żghira minn għand din il-Kumpannija."

*Domanda: "Kem għamilt servizz fil-Korp tal-Pulizija?"*

Twegiba: "Jiena għamilt 25 sena servizz u f'Novembru, 1955, jiena rtirajt bil-pensjoni."

*Domanda: "Qabel ma ntemmu din l-intervista, tiftakar f'xi haġ'ohra li ggiblek memorji sbieħ konnessi ma' xi investigazzjoni kriminali?"*

Twegiba: "Jekk noqgħod nirrakkonta ma nispiċċaw qatt, biss nixtieq insemmi li kelli bosta rakkomandazzjonijiet ta' xogħol li kont involut jiena fih u dawn

kienu jidhru fil-Police Orders. Però llum irrid nirreferi għal dik is-serqa kbira minn N.A.A.F.I. Canteen ġewwa l-Forti Rikasoli. Għall-bidu, il-każ kien ġie investigat bla ebda riżultat mid-Dockyard Constabulary; is-suspetti skond huma, kienu xi Maltin, iżda wara li dhalna ahna l-Pulizija, jiena bl-għajnuna ta' zewġ kuntistabblijiet mis-C.I.D., irnexxielna wara għassa twila mohbijin f'katakombi taht is-swar tar-Rikasoli, li naqdbu "red-handed" erba' baħrin Inglizi li kienu kkommettew is-

serqa, kif ukoll nigbor ir-rifurtiva."

L-ex Surgent Salvu Fava mbagħad ha l-okkażjoni biex jesebixxi "cutting" (li qed tidher f'pagna 18) minn gazzetta lokali fejn jissemma li snin ilu huwa kien offra l-ghoti tad-demmm tat-tip "O" lil Papa Gwanni XXIII. F'"cutting" ohra (li tidher f'pagna 18) jirriżulta li fl-1956, is-Sur Fava kien heġġeġ għal voluntiera fl-ghoti ta' l-għajnejn immedjatament wara mewthom, għal skopijiet ta' traspjanti minn speċjalisti tobbja ta' l-għajnejn,

### Profil Fuq

## PHILIP SPITERI, EX PC. 55

Il-Kuntistabbli Spiteri, daħal membru ta' l-Ghaqda mill-origini tagħha.

PC. Spiteri daħal fil-Korp tal-Pulizija bhala Riservista fis-16-5-31, kien ġie mogħti n-numru 55 u baqa' bl-istess numru sakemm hareġ mill-Pulizija.

Huwa ġie kkonfermat 3rd Class PC fl-1-12-31 u stazzjonat M.T. Dept. Fl-1-12-36 ġie kkonfermat 2nd Pc. u stazzjonat C.I.D. u konfermat 1st. Pc. fl-1-

4-47 fejn ġie stazzjonat il-Water Police District fejn baqa' sal-5-1-52 meta rtira mis-servizz bil-pensjoni.

Fil-waqt li nitolbu lill-Mulej jagħtih il-mistrieħ ta' dejjem, il-President, l-Uffiċjali u l-Membri tal-Kunsill, jagħtu l-kondoljanzi lill-Familjari tiegħu.

### MUTUAL HELP ASSOCIATION

Dawn il-Membri shabna hallew dan il-wied ta' dmugh matul ix-xhur li għadew, biex dahlu fis-Saltna tas-Sema.

### AGHTIHM O MULEJ IL-MISTRIEH TA' DEJEM.



**EX-P.C. 55  
PHILIP SPITERI**



**P.C. 41  
CARMEL BARBARA**



**P.C. 434  
GAETANO MALLIA**



**P.C. 216  
GERALD TANTI**

**Lehen  
l-Ghaqda  
tal-Pulizija  
Pensjonanti**



## **INTERVISTA MA' EX-P.S. 268 SAVIOUR FAVA**

dik li l'um qed issir kampanja siewja favur tagħha mill-popolari Lions Club ta' Malta. Is-Sur Fava spiċċa l-intervista b'dan il-kliem: "Jiena nappella lil min huwa b'saħħtu sabiex meta jista' jmur jagħti d-demm, li f'bosta każi, huwa l-uniku mezz biex isalva l-hajja ta' haddiehor, u li jkun hemm aktar voluntiera li joffru għajnejhom immedjatement wara mewthom biex jintużaw f'operazzjonijiet kirurgiċi ta' l-għajnejn."

Kopja ta' ittra li ex P.S. Fava wassal lill-Qdusija Tiegħu l-Papa Gwanni XXIII.

**"IL-BERQA - 1962"**

# **MALTI LI OFFRA D-DEMME LILL-PAPA GWANNI**

**MIR-REPORTER TAGHNA**

**•META l-Qdusija Tiegħu l-Papa Gwanni XXIII kien qieghed fl-eqel tal-aħħar marda tiegħu, minn hawn Malta harget offerta ta' wiehed li kien lest biex jagħti d-demm lill-Papa jekk ikun hemm bżonn. Din l-offerta ta' demm ghamilha s-Sur Salv Fava mill-Kalkara, ex-Surgent tal-Pulizija.**

Is-Sur Fava ghamel l-offerta tiegħu b'ittra mibghuta lis-Segretarju tal-Istat tal-Vatikan, il-Kardinal Cicognani, fit-30 ta' Mejju.

Is-Sur Fava offra li jhallas minn butu l-vjaġġ minn Malta għal Ruma u lura jekk jiġi mitlub biex jagħti d-demm tiegħu, li hu tal-grupp "Universale".

Għal din l-offerta tiegħu, is-Sur Fava rċieva dan li ġej mis-Segreteria ta' l-Istat tal-Vatikan:

"Nirringrazzjawk għax-xhieda ta' venerazzjoni ta' iben lejn il-Qdusija Tiegħu l-Papa Gwanni

Kopja ta' l-ewwel appell li kien sar f'Malta għall-'Eye Donors' mill-ex P.S. Fava

**TIMES OF MALTA, THURSDAY OCTOBER 25, 1956**

**CORRESPONDENCE:**

## **APPEAL FOR EYE DONORS**

**TO THE EDITOR TIMES OF MALTA**

Sir, - I am sure many people in Malta would welcome an appeal for a most unselfish and esteemed sacrifice, namely that of eye donating by the dying, for blind persons. There may be some people who would be prepared to bequeath their eyes if they knew that good use could be made of them.

While returning home recently, a friend urged me to write on the subject, in any leading newspaper. The idea should serve as a matter for discussion which might eventually lead to donors.

The people of Malta have always been in the forefront of charitable works. It would be a great achievement were this to succeed. As it is known, in Italy this heroic

deed was made by a Catholic priest on his death and it proved a great success. A number of donors are registering daily. Such volunteers are held in great esteem.

So let us make our life worthwhile, by making such a noble sacrifice. We can give happiness to those who are continually begging our help in order to be happy. An Eye Donors Movement would indeed be worthy of the highest praise.

Yours truly,  
Kalkara. S. FAVA.

**Lill-Onor.  
Dr. George Hyzler M.D.,  
Segretarju Parlamentari  
għas-Sahha,  
Triq Merkanti, Valletta.**

**Onor. Sinjur,**

**RINGRAZZJAMENT**

Gejt imqabbad mill-Kunsill biex inwassal l-apprezzament tagħna meta lqajt it-talba mressqa mill-Ghaqda, biex zewġ membri jkun jistgħu jżuru lill-Pulizija Pensjonanti rikoverati fl-Isptarijiet ta' l-Istat, wara l-11.00 a.m.

Ahna napprezzaw il-koperazzjoni tiegħek għax b'dan il-ġest ma nkunux ta' tfixkil għal hin allokati għall-familji tal-pazjenti.

Filwaqt li nerga' nirringrazzjak, nawguralek suċċess fil-hidma tiegħek, inselli għalik,

**Għodni tiegħek,  
LOUIS MUSCAT,  
Segretarju.**

# THE CHOICE OF A SUPERSTAR



The star studded "accent" bathroom suite could have been specially designed for the famous star Joan Collins.

The bathroom collection with space age lines is the ideal bathroom for all who, like superstar Joan Collins, love the exclusive and unusual — and want luxury even in the bathroom.

Ideal Standard, your ideal bathroom.

*Ideal  
Standard*

*Available from Ideal Standard's  
Sole Agents and Distributors in Malta:*

**ROGER  
SATARIANO  
& SON LTD.**

122 Msida Valley Road, B'Kara, Tel: 442769, 491017



# FISHER

*The first name in high fidelity*



## The Fisher Video P-990. Black. Slim. Exciting.

• Outstanding picture quality with H.Q. • Stereo sound recording in veritable HIFI quality • 3 video, 2 audio heads • Stereo and dual-soundtrack TV recording • Level meter with peak-hold circuit • Synthesizer cable tuner for 40 channels • 14-day 7-programme timer • QTR function • APS automatic programme search • Automatic Play: pre-recorded cassettes start automatically when inserted • Slow motion continuously variable from still to normal speed • Quick Motion • Picture Search forward/reverse at 5 times normal speed • Interference-free still picture • Frame advance • Digital remaining-tape indication • Display panel showing play mode, time, tape counter, channel weekday and timer settings • Headphone jack with separate volume control • Tracking control • Tape selector switch for different video sources • Complete with infrared remote control for 32 functions, including power on/off • Only 95 mm high.



### **Head Office & Servicing Department**

Joe Gasan Street, Pietà — Tel: 229608

### **Branches:**

City Gate, Valletta Tel: 226384

Roadstar, Bisazza Street, Sliema Tel: 317522

Atari, Paola Square, Paola Tel: 782809

1, Mannarino Road, B'Kara.

# PAGNA GĦAN-NISA

Minn MARY

## IL-“GENERATION GAP”

Waħda mill-problemi universali li tolgot lilna n-nisa direttament, hija dik magħrufa bħala l-“Generation Gap” – l-andament ta’ kif iġixxu ż-żgħażaġh paragnat ma’ dak ta’ kif iġixxu l-antenati tagħhom. M’ihiex xi problema li qatt ma smajna fuqha, jew qatt ma ddiskutejnihha, u dejjem naslu għall-istess konklużjonijiet – it-tort taż-żgħażaġh – jew it-tort tal-kbar!

M’inhix beħsiebni nidhol fil-meritu ta’ minn johloq il-problemi, izda din il-kwistjoni nikkompara bħal sikkina taqta’ minn żewġ naħat. Iz-żewġ partijiet għandhom il-ħażin u t-tajjeb tagħhom, u xieraq għalhekk li naraw x’inhil r-raguni għal dan in-nuqqas ta’ qbil bejn iż-żgħażaġh u l-antenati tagħhom. Din il-problema ta’ nuqqas ta’ qbil f’dan ir-rigward ma teztix biss bejn il-ġenituri u wliedhom, izda teztix f’diversi modi fis-socjeta’ tagħna.

Nieħdu l-problema tal-familja – in-nuqqas ta’ qbil bejn il-ġenituri u l-ulied. Nghiduha ċar u tond li din il-problema teztix l-aktar fejn ma teztix dixxiplina – dixxiplina li trid titrawwem fl-ulied sa minn ċkunithom – u mhux wara li nhalluhom jagħmlu li jridu fi ċkunithom għax noqogħdu niggustawhom, imbagħad nibdew naraw kif se ngħallmuhom ma jagħmlux dak li konna niggustawhom jagħmlu u li issa qiegħed idejjaqna.

Inutli li lil uliedna – per eżempju, ngħidulhom li fi zmienna konna nidhlu fit-tmienna ta’ filgħaxija lura d-dar (jekk mhux qabel ukoll) għax malajr johorgulek b’xi waħda sarkastika – “imma dak iż-żmien kontu għadkom bil-lampi tal-Pitolju”. Irridu nfehmuhom għaliex nixtiequhom id-dar filgħaxija kmieni, u mhux f’nofs iljieli. Nispjegawhom xi tfigħer il-kelma ‘dekor’ u li din jistgħu jkollhom bżonnha meta jġu biex isibu s-sieħba jew sieħeb tagħhom. Dan huwa d-‘djalogu’ li jehtieg isir bejn il-ġenituri u l-ulied bl-aktar mod serju u mingħajr hafna għajjat u glied.

Bosta huma dawk li jirragunaw li liż-żgħażaġh tal-lum ma tfemhom b’xejn, u tkun qed tagħzaq fl-ilma tipprova

tfemhom ċerti affarijiet. Għalhekk fil-bidu għedt li d-dixxiplina trid titrawwem fit-tfal minn ċkunithom, biex fl-iżvilupp tagħhom inti tkun tista’ iżzommhom kemm jista’ jkun il-bogħod minn xi saram. Uħud jirragunaw ukoll li lit-tfal iżzommhom biss taħt il-kappa tiegħek sakemm jifrarfu, u llum qegħdin naraw li dan it-‘tfarfir’ qiegħed isir ta’ eħtaż għira f’dik li hi mentalità addoloxxenti. L-ulied tal-lum qegħdin iħossu li ta’ erbatax/ħmistax il-sena huma kapaċi jiddeċiedu x’inhu tajjeb u ħażin għalihom, u mhux kemm taqbad tikkonvinċihom li dak li qegħdin jagħmlu huwa ħażin, izda xorta għandu jsir l-igġwidar neċessarju biex nevitawhom li jaqgħu f’xi saram.

Importanti mbagħad li mhux kemm naqbd u nippruvaw niggwidaw lil uliedna, fi ċkunithom u f’żoghżithom, imbagħad fl-istess waqt inkunu aħna stess ta’ l-akbar eżempju ħażin għalihom. Kif tippretendi li lil uliedek tmexxihom u tigwidhom meta t-tajjeb li nkunu rriduhom jagħmlu – nagħmlu aħna l-oppost tiegħu! Jekk iż-żgħażaġh iħarsu lejna għat-tregija f’ħajjithom, x’jistgħu jibbenefikaw jekk ħajjitna qisha lanċa f’baħar im-qalleb!

Lit-tifel tiegħek ta’ erbatax/sit-tax il-sena xi dritt għandek tikkoreġih għax qal ‘ħaq’ – meta kif jisbaħ filgħodu jisma lilek iżżarrat xi waħda tfarrak il-gebel! U mhux hekk biss, meta wkoll ma trid ixemma lill-ġirien ukoll!

Din il-problema tal-“Generation Gap” m’hiex xi waħda li żvolgiet ruhha matul dawn l-aħħar snin – ilha hemm minn żmien il-bidu tad-dinja, u huwa diffiċli ferm sabiex issolvi ruhha. Għalkemm hawn bosta għaqdiet – kemm taż-żgħażaġh kif ukoll

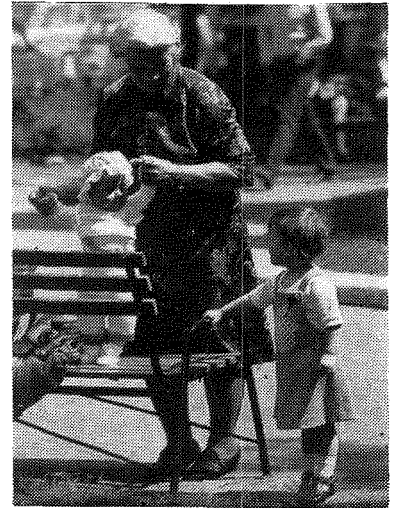

L-ulied iħarsu lejna għat-tregija tajba...qegħdin nagħmlu dan?

tal-anzjani, u diversi drabi saru laqgħat fejn fihom ħadu sehem iż-żewġ partijiet, jibqa’ l-fatt li minkejja li saru bosta sforzi sabiex isir xi haġa biex din il-problema tittaffa, għadna lura wisq biex ngħidu li ta’ l-anqas bdejna.

Għalhekk nishaq li l-ewwel sforz għandu jsir fil-familja stess. Aħna n-nisa u ommijiet tad-dar għandna nagħmlu hilitna kollha sabiex lil uliedna nfehmuhom, bil-kwiet u bil-galbu, li din il-problema ta’ l-anqas ma għandhiex għalfejn tkun teztix f’darna, li b’daqsxejn ta’ kelma tajba u djalogu addattat fil-familja tagħna stess għandna nagħtu bidu sabiex din il-problema tibda tittaffa l-ewwel minn darna stess, imbagħad la jkun hemm ċertu qbil fuq diversi materji familjari, dan l-istess ftehim jibda johroġ barra darna, u għalkemm it-tajjeb huwa diffiċli biex jiġi kkupjat, jista’ ta’ l-anqas iservi bħala pedament għal soluzzjoni għal familja oħra.

## SUBSCRIPTION TO THE INTERNATIONAL CRIMINAL POLICE REVIEW

The subscription covers the 6 annual issues (total: 200 pages). Please complete the form below in capital letters and return with your payment to one of the following addresses:

Arabic, English and French editions:  
ICPO-Interpol  
General Secretariat  
B.P. 205  
92212 Saint-Cloud CEDEX, FRANCE

Spanish edition:  
Dirección General de Policía  
Oficialia Mayor  
General Pardiñas 90, 6a planta  
Madrid 28006, SPAIN

### RATES for 1987 subscription: (in Swiss francs)

All rates include postage.

– Arabic, English and French editions: France: 28 Swiss francs; Other countries: 32 Swiss francs

BY AIRMAIL:

Europe: 37 Swiss francs; The Americas: 46 Swiss francs;  
Asia: 51 Swiss francs; Africa and Middle East: 40 Swiss francs

– Spanish edition:

Spain: 1,000 pesetas; Other countries: 1,300 pesetas

### 1987 I.C.P.R. SUBSCRIPTION FORM

NAME (or corporate name) \_\_\_\_\_

FORENAME \_\_\_\_\_

PROFESSION \_\_\_\_\_

ADDRESS \_\_\_\_\_

\_\_\_\_\_ CITY \_\_\_\_\_ POST CODE \_\_\_\_\_

COUNTRY \_\_\_\_\_ Subscriber's number (for renewals) \_\_\_\_\_

Number of subscriptions required in each language (please place the appropriate number in the box opposite the language(s) of your choice):

Arabic       English       French       Spanish

PAYMENT ENCLOSED, i.e.

For Arabic, English and French editions:  
\_\_\_\_\_ Swiss Francs (or equivalent in  
another currency – preferably French francs or  
U.S. dollars – i.e. \_\_\_\_\_)

Date: \_\_\_\_\_

Signature and/or authorized stamp:

by: – Post office draft to Paris post office account  
C.C.P. Paris 13.492-63 (in French francs exclusively)  
– Cheque made out to I.C.P.O. – Interpol

For Spanish edition: \_\_\_\_\_ pesetas (or  
equivalent in your country's currency, i.e. \_\_\_\_\_)

by: Cheque made out to Administración Revista Interpol.





A long tradition  
dating back to 1925

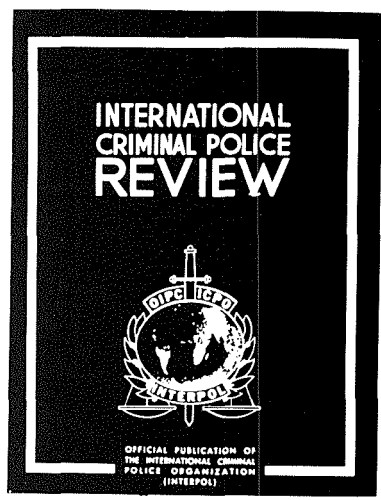

Contributions from  
people actively involved  
in law enforcement



A forum for sharing the wealth  
of experience acquired in  
Interpol's 142 Member States



Worldwide circulation  
in four languages

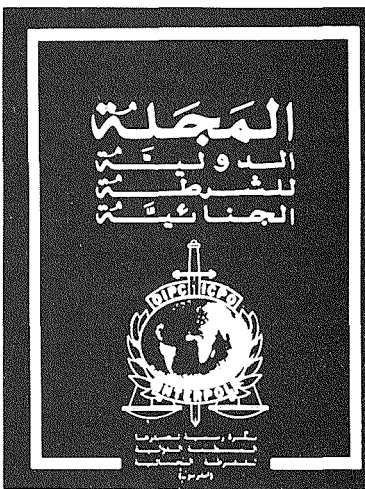

Available on  
subscription only

# PAGNA GHAT-TFAL

● Try making a simple paper flower – an old-fashioned rose or a daffodil or a tulip. After a little practice you may find you want to go on and make many different and more difficult flowers.

You will find the instructions for making each flower or spray of flowers very simple. Follow them carefully. Make bouquets of flowers as gifts for your friend, or for centerpieces for your table, when you are having a party.

## PART 3 TULIPS

● Make patterns of the centre of the tulip, the petals, and the leaves (Patterns a, b and c).

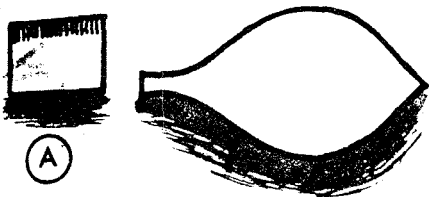

(A)

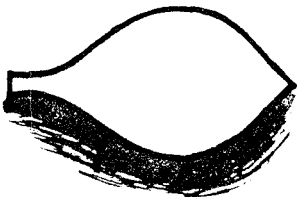

(B)

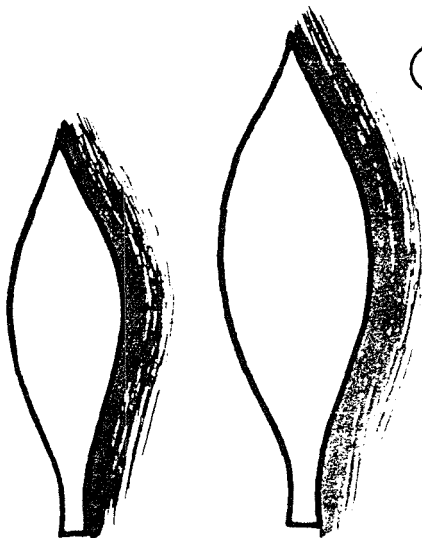

(C)

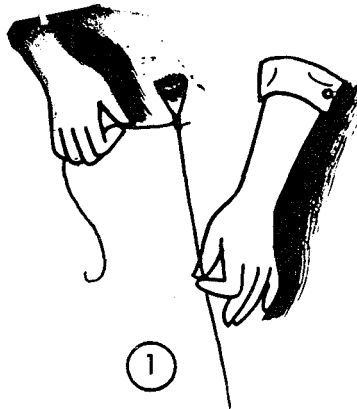

(1)

Cut out of yellow or red paper a centre for the flower, using Pattern a. Make little cuts along the edge where the black lines are drawn. This will give the effect of a fringe. Shape this into a cup and tie it to one end of a 9" wire stem (picture 1).

Using Pattern b and cut out 6 petals in yellow or red paper. Tie these, evenly spaced, around the base of the centre cup. To do this, place the petals back to

front and upside down, around the base of the centre cup, tie them, then turn them up around the centre cup (picture 2).

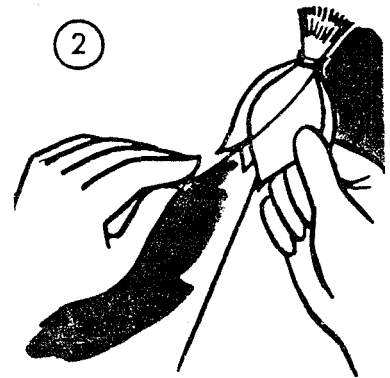

(2)

Cut 3 long, spear-shaped leaves out of green paper, using Pattern c, and tie these around the stem.

Wrap the stem with green paper or florist's tape (Picture 3).

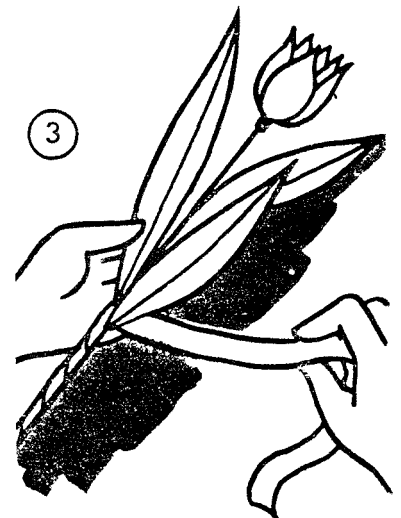

(3)

Rebbieh tal-Kompetizzjoni  
tat-Tfal No. 3

Sharon Bunce  
'Yvonne' Liedna Str.,  
Paola.

# Percevering Percy P.C.

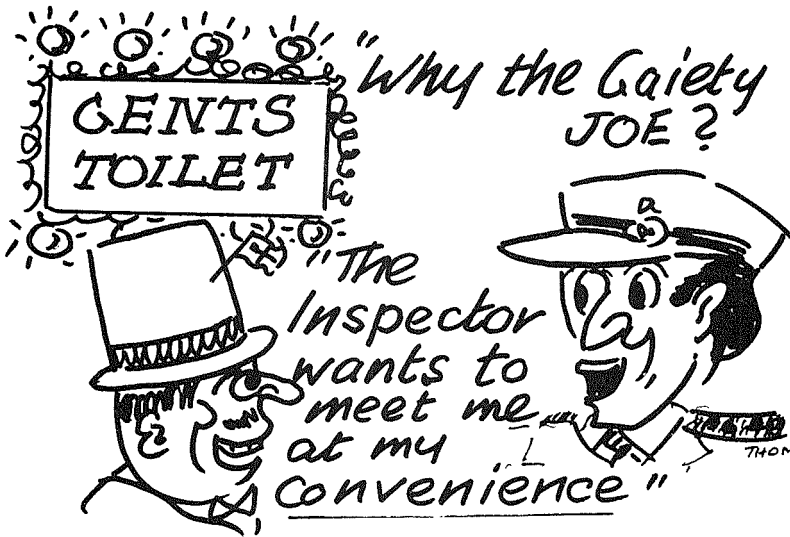

# TBISSEM FTIT....

## PROVA EĆCELLENTI

– Magistrat: “U xi provi ghandek biex tgiddeb l-akkuza kontrik ta’ sewqan esagerat, eh?”.

– Sewwieq: “Bizzejjed nghidlek, Sinjur, li kont sejjer ingib lil kunjata tqatta’ gimgha d-dar ghandna!”.

\* \* \*

## BOMBS AWAY

– Imhallel: “Mela int u zewgek ma kontux irrangajtu, u ma sseparajtux. Dan x’kien ergajt gejt quddiemi, sinjura?”

– Zewgha: “Tort tieghi, sinjur, ghax ... ma lqatthiex sew bil-flixkun li tfajtilha!”

\* \* \*

## ARMONIJA!

– Hu: “Meta nkun mieghek, hekk, wiċċi ma’ wiċċek, qalbi, nisthajjlmi fi gnien mimli fjuri. X’finezza, xi fwieha, xi gmiel, xi...”

– Hi: “U jien nisthajjlmi wiċċi ma’ xi pjanta tal-Kaktus ... b’dik il-lehja, ja mahmug!”

TISLIBA Nru. 3

– BI PREMJU TA’ LM5

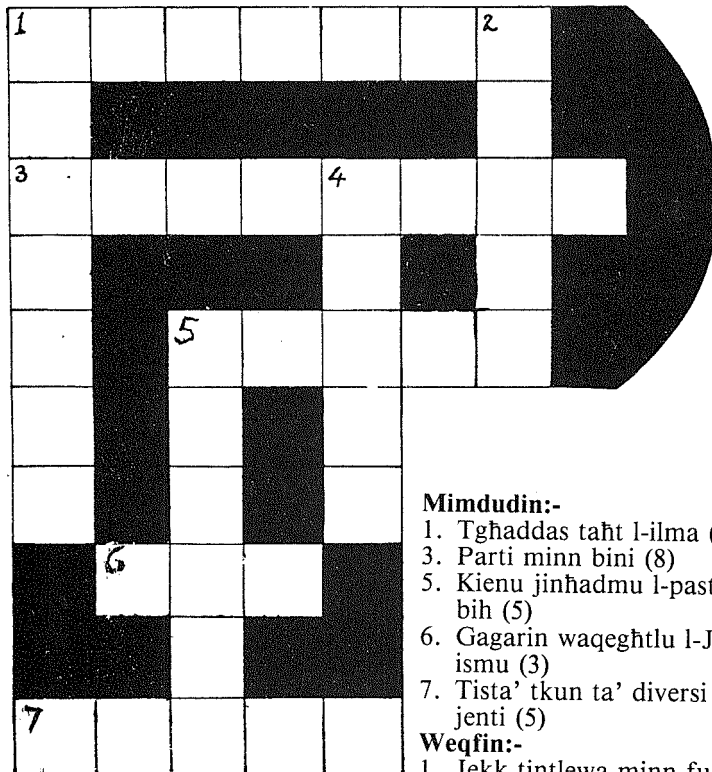

### Mimdudin:-

1. Tghaddas taht l-ilma (7)
3. Parti minn bini (8)
5. Kienu jinhadmu l-pasturi bih (5)
6. Gagarin waqeghtlu l-J minn ismu (3)
7. Tista’ tkun ta’ diversi ngredjenti (5)

### Weqfin:-

1. Jekk tintlewa minn fuq din tista’ tfekkek saqajk (7)
2. Wiehed mix-xhur tas-sena (5)
4. Parti minn funeral (5)
5. Kienet fuq it-Titanic meta beda jeghreq (6)

Ibaghtu t-twegibiet taghkom lill-PC 512 M. Ellul, Police Library, G.H.Q., Floriana.

## SOLUZZJONI TISLIBA Nru. 2

TISLIBA Nru. 2 – BI PREMJU TA’ LM5.

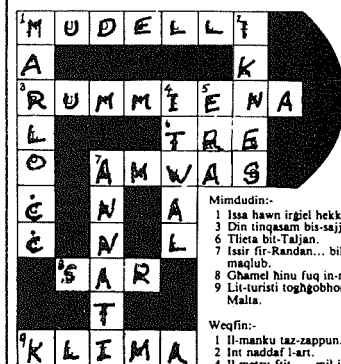

### Mimdudin:-

- 1 Issa hawn irgjel hekk ukoll.
- Din tinqasam bis-sajjeta.
- Tieta bit-Taljan.
- Issir fir-Randan... bil-maqlub.
- Ghamel hinu fuq in-nar.
- Lit-turisti toghobhom ta' Malta.

### Weqfin:-

- 1 Il-manku taz-zappun.
- Int naddaf l-art.
- Il-metru fit... mil-jarda.
- Ta' oerzu zmien.
- Ta' zmien il-qedem?

## REBBIEH TA’ TISLIBA Nru. 2

Mrs. C. Monreal  
6/Residual Blk  
Wigi Rosato Street  
Cospicua

# STATUS QUO

• THE story of Status Quo is a tale of two decades, two musical directions but only one group.

It is hard to believe that Status Quo began life in the music business as long as 1962, for today they are superstars status in the U.K. and very much a group of the 70's. Their secret of continued success is that they have been adventurous enough to progress musically with the times, so that their talents and energies are always blended into a contemporary sound.

## MID-DINJA MUŽIKALI

— TAGHRIF MIĞBUR MIS-Sgt. CHARLES MARSH

Their initial break into the charts came in early 1968 after a hard apprenticeship of six years playing holiday camps and acting as a backing group. Pictures of Matchstick Men was their first hit followed swiftly by Ice In The Sun. Both singles were pop psychedelia and extremely contemporary but it was not necessarily a sound guaranteed to keep the group riding high in the popularity polls for the years to come.

Quo recognised the possible transience of their attraction and, when the hits dried up, they took to time re-think their musical direction and decided to set up a new image, audience and reputation in the progressive rock circuit.

Against all odds they did just this and emerged in the early 70's

to meet with a rapturous reception, sell out tours and a fanatical following—all of which they have maintained to this very day. Status Quo were brave enough to take a long, hard look at themselves and the music business .. and it paid dividends!

In the collection (Status Quo Greatest Hits) we look at the Status Quo of the late '60s. It is a compilation of great interest to all their fans, for not only does it feature their hits of the time but many other selected recordings made before their change in musical directions. They were as much a group of the '60s as they are of the '70s and this must surely be a true collectors item.

In the '80s we heard about Status Quo with the hit 'You're in the Army now'.





# TEG industries Ltd.



## TUBULAR & MAHOGANY FURNITURE WORKS

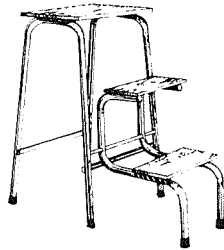
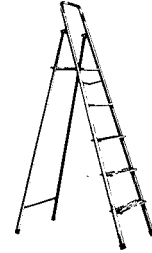

Factory: 37, PSAILA STREET, B'KARA TEL: 444457

Showroom: **RICHARD BUSUTTIL** - 116, MANNARINO RD., B'KARA TEL: 442257



## THE CATERING CO-OP LTD.

operators of

### Mc:BURGERS

*Freedom Square, Valletta. Tel. 222716*

*Bisazza Street, Sliema. Tel. 335319*

### Cafè De La Vallette

*City Gate, Valletta. Tel. 227704*

### M.V. GHAWDEX

*Restaurant - Cafeteria*

OUTSIDE CATERING AND CANTEEN OPERATORS





# ID-DRITT U D-DMIR TAL-PULIZIJA

- 1) Il-Parlament Malti reġa' gie inawgurat ufficjalment nhar il-Hamis, 9 ta' Lulju, 1987.
- 2) L-Eccellenza Tieghu l-Agent President tar-Repubblika ta' Malta, is-Sur Pawlu Xuereb, b'dinjta u b'serjeta liema bhalha, habbar il-programm tal-gvern il-gdid, li fost l-ohrajn tkellem fuq il-Korp tal-Pulizija, u wera l-intenzjoni futura tal-gvern, ghal riformi fil-Korp tal-Pulizija billi wriena qafas ta' pjan billi sostna diversi principji fundamentali, kif ukoll habbar diversi mizuri preliminari b'risq il-Korp tal-Pulizija u b'risq il-poplu taghna.
- 3) Fost il-principji li se jkollhom attenzjoni speċjali nsibu, li:
  - A) il-pulizija hu l-mezz skond il-ligi biex tinzamm l-ordni u l-paci pubblika.
  - B) il-pulizija hu u jibqa' l-mezz biex isehh id-dritt baziku tal-helsien skond il-ligi.
  - C) il-pulizija u l-lealta tieghu lejn il-Kostituzzjoni u lejn il-poplu hu servizz tad-dritt.
  - D) il-pulizija, l-onesta u l-hila fil-qadi ta' dmirietu hu l-bazi tal-harsien tal-ligi.
- 4) Fost il-mizuri mhabbra, li se jghinu "il-Korp tal-Pulizija, insibu:
  - A) il-bzonn ta' ghajjnuna izjed fl-kundizzjonijiet tax-xoghol
  - B) tibdil fl-organizzazzjoni.
  - C) tahrig intensiv.
  - D) kwalifiki ahjar.
- 5) Din l-attenzjoni speċjali fuq dawn il-principji u fuq ohrajn, kif ukoll, din il-kura fil-mizuri mhabbra, din tissejjah inizzjattiva bi dritt u skond id-dmir ta' l-awtorita, li hi forma ta' zabra tant mehtiega fi stagun xitwi, ghalkemm ninsabu fis-sajf!
- 6) Proprjament, l-Eccellenza Tieghu, f'isem il-gvern ma qal xejn gdid. Ghax id-drittijiet u d-dmirijiet taghna u ta' haddiehor ilna nafuhom sa mill-1814. Ghax din kienet u ghadha l-libsa taghna, li nafu nilbsuha. Ninsab cert li l-Eccellenza Tieghu u l-gvernijiet jafuh dan. Imma jista' jkun li mhux kulhadd jaf jilbes sewwa din il-libsa.
- 7) Imma huma jwissu ghal kemm-il darba. Bhal omm hanina li twissi 'l uliedha. Bhal dak il-konfessur, li fil-Qrar iwiddeb elf darba. Ghax il-pulizija, ahna wkoll, "Humani Sumus", bhall-kumpliment tal-poplu. Im-



- 8) ma jehtieg li kulhadd indaqs, nitghallmu nilbsu sewwa l-libsa taghna. Ghax dan hu impenn sagrosant, li fix-xoghol taghna ma nistghux noffru konfini u kuluri.
- 9) Imma l-ebda omm, konfessur jew gvern ma jiehu pjaċir jaraw 'l uliedhom jonqsu mid-dmirijiet taghhom. Ghalhekk iwissu u jergghu jwissu u jfakkru, biex id-dmirijiet u d-drittijiet jimxu id f'id. Biex ma jinbarax hadd. Biex igawdi kulhadd. Biex kulhadd ighix hajtu fil-paci u t-trankwillita.
- 10) Ghalhekk inhossni cert li kull wiehed minna jipprometti li bl-ghajjnuna ta' Alla nwasslu l-Korp tal-Pulizija taghna ghal rebbiegha mwarra, b'sahhitha u li ttul f'interest wiehed, dak nazzjonali.
- 11) Frott id-dielja hu xoghol il-bniedem. J'Alla l-imqass taz-zabra jintuza mill-bniedem bis-sengha u bl-onesta. Ghax zabra mhux tajba u mhux fi zmienha ma taghtix frott bnin. Zabra tajba u f'waqtha biss tkun effikaci.
- 12) Hajr minn qalbi lill-Eccellenza Tieghu l-Agent President tar-Repubblika li reġa' wassliha l-messagg tieghu. Messagg patern.
- 13) Nawgura lill-Korp tal-Pulizija taghna u lill-poplu Malti u Ghawdxi, li bl-ghajjnuna t'Alla u bir-rieda konvincenti taghna naslu nghelbu kull diffikulta.



# Martin Luther King

Minn  
J. ATTARD

● Kien Diċembru ta' l-1955 meta Rose Parks, Amerikana sewda rikbet fil-karozza tal-linja f'Montgomery, Alabama. Hija kienet għajjena hafna wara x-xirja li kienet għamlet u b'hekk poggiet bil-qeghda. Wara ftit fil-karozza telghu xi nies bojod u l-kunduttur qallha sabiex tqum għax f'Alabama is-suwed setgħu joqogħdu bil-qeghda biss jekk ma jkunx hemm bojod bil-wieqfa. Izda Parks irrifjutat li tqum u l-kumpanija tax-xarabank tellagħha l-qorti għax f'Alabama kien hemm liġi li trid tobdi lill-kunduttur, u giet immultata.

Is-suwed ta' Montgomery tant irrabjaw li rrifjutaw li jużaw ix-xarabanks tal-kumpanija dment li ma jitrattawhomx tajjeb u bil-pulit daqs il-bojod. Kien hemm grupp ta' suwed li organizzaw soċjetà li sejhulha 'Montgomery Improvement Society' immexxija minn Martin Luther King. Kien ta' periklu li tmexxi għaqda bħal din għaliex il-bojod kienu kontra li s-suwed jigu ttrattati bħalhom, fil-fatt King gie mhedded u anke attakkat. Però huwa ma halliex lis-suwed jirritaljaw għax kien kontra kull tip ta' glied u vjolenza. Sadanittant huwa għamel l-ewwel rebħa għaliex il-Qorti ta' Washington qalet li s-suwed għandhom dritt joqogħdu bil-qeghda fix-xarabank daqs kemm kellhom dritt il-bojod. Huwa kien jemmen fit-tagħlim ta' Kristu u għalhekk kien kontra l-vjolenza. Kien jemmen f'dik li l-Inglizi jghidu 'passive resistance' jgħid li tagħmel it-triq diffiċli lill-oppożizzjoni mingħajr ma twegga' u ssawwat lil hadd.

## MITFUGH IL-HABS

Sadanittant Martin Luther King lahaq President ta' Għaqda Kristjana li kienet tinkludi n-nofsinar ta' l-Amerika kollha. Is-suwed ma setghux joqogħdu fi snack bars u għalhekk l-ewwel metodu li użaw kien 'sit in'. Xi studenti minn Carolina ftehm u li joqogħdu hemm bil-qeghda għall-granet shaħ bi protesta. Meta ha parti fiha King, gie arrestat u mitfuh il-habs.

Minn hawn beda jorganizza demostrazzjonijiet fl-Amerika kollha u kien determinat li s-suwed ikollhom dritt li jivvutaw, li jmorru fl-istess universitajiet u skejjel u li jkollhom jobs tajbin



“... kulhadd għandu jkollu xi skop għal x'hiex imut. Min m'għandu l-ebda skop għal mewt mhuwiex denn li jghix.”

Martin Luther King

daqs il-bojod. Fl-1963 Martin Luther King għamel dimostrazzjoni fil-Belt ta' Washington li gabret madwar 200,000 ruħ inklużi bojod li kienu jappoggjaw lis-suwed. Fl-istess sena huwa rċieva l-premju Nobel għall-paċi u l-premju ta' 10,000 lira li ngħata tah lis-Soċjetà għad-drittijiet tal-Haddiema. Il-hidma tiegħu komplet tagħti l-frott għaliex kullegġijiet skejjel u jobs bdew jinfethu għas-suwed ukoll, kif ukoll setgħu jidhlu f'Restaurants u fil-gonna pubbliċi.

Izda f'hafna stati kienet diffiċli

li jivvotaw għaliex riedu jgħaddu minn eżamijiet diffiċli li l-bojod ma kellhomx għalfejn jagħmluhom. Hawnhekk is-suwed kienu ġew attakkati, imsawta u saħansitra maqtula. Martin Luther King kien jaf li xi darba din ix-xorti hażina kienet se tmiss lilu.

Baqgħu magħrufa dawn il-kliem li ntqal minn King. 'Every man should have something he'd die for. A man who won't die for something isn't fit to live. Fil-fatt huwa kien gie maqtul minn estremista abjad fl-1967 meta kellu biss 38 sena.





**GATT BROTHERS**  
**(MOSTA)**  
**LIMITED**

GENERAL BUILDING  
CONTRACTORS  
**FORT ROAD, MOSTA,**  
**MALTA**

Telephone 441132-440111

Cables: Limestone

*For Professional Service*

Book your Wedding, Engagement etc.  
in photos and video  
at

## **AGIUS PHOTO STUDIOS**

136, Pawla Square  
Pawla. Tel. 826270

3c, St. Sebastian Square  
Qormi. Tel. 487009

*THE NAME IS THE GUARANTEE  
YEARS AND YEARS OF EXPERIENCE*

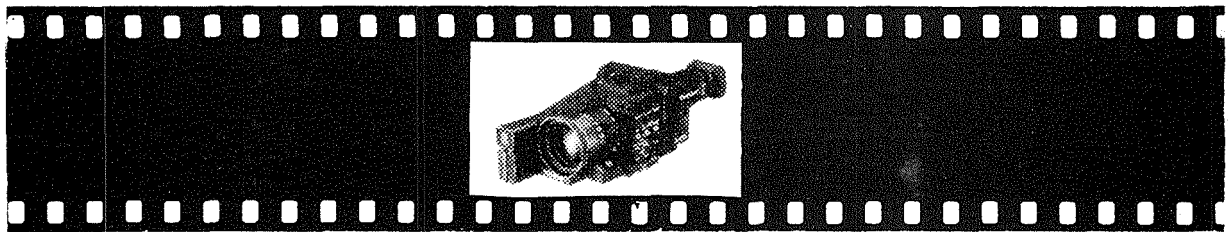

## **PEUGEOT Power Tools and Woodworking Machines**

**PROFESSIONAL  
and  
D.I.Y.  
Series**

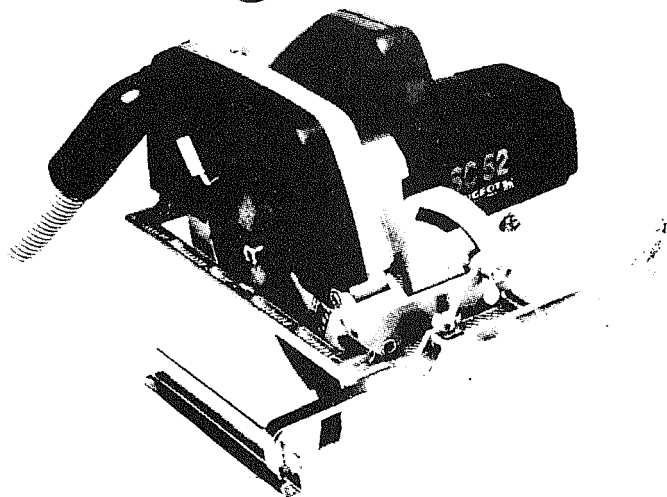

*Sole Agents and  
Distributors:-*

### **CARMELO GAUCI LTD.**

**"CARGA" NEW STR. in QORMI RD. ST. VENERA. TEL: 443861-445/17**



# L-AKKWARJU

Kitba ta' TARCISIO VELLA

IT-TIENI PARTI

• **F'DAN l-artiklu se naghti xi tagħrif fuq kif wiehed jgħaqqad il-vaska. Jekk wiehed ikun xtara l-akkwarju, jġifieri l-vaska biss, allura kull ma jkollu bżonn jixtri huwa l-apparat biex jagħmlu jiffunzjona. Jekk wiehed ikun iddeċieda li jarmah kollu hu – jġifieri li l-vaska jagħmilha huwa wkoll, allura ikun daħal għal aktar xogħol imma jkun sodisfatt li dak li għandu jkun eżatt dak li xtaq.**

Sa hawn suppost li diġà ddeċidejna fuq il-post fejn se nqegħdu l-Vaska, u l-qies tiegħu. Mela issa nmiss li nixtru l-ħġieg.

Il-ħxuna tal-ħġieg jiddependi mill-kobor ta' l-akkwarju. Akkwarju ta' 1000mm wisa, 500mm f'fond, u 500mm għoli jrid ikollu l-ħġieg ta' ħxuna mhux inqas minn 6mm. Meta mmorru għand l-'Ironmonger' (jew kif huwa aktar magħruf 'taż-Zebgħa'), irridu nispjegawlu l-ħġieg irid ikollu l-kantunieri 90.

Ħaġ'ohra li rridu noqogħdu attent huwa li x-xifer tal-ħġieg ma jkunx jaqta'. F'każ li jkun jaqta', kull ma rridu nagħmlu huwa li niddubbaw biċċa 'mola', – jekk jkun 'Garborandum' aħjar, u nħokku x-xifer biha. Wiehed irid joqgħod attent li din il-biċċa xogħol jagħmilha b'attenzjoni kbira, għaliex xifer ta' ħġieġa taqta' aktar minn sikkina mis-nuna.

Meta jlesti din il-biċċa xogħol wiehed għandu jfarfar tajjeb il-frak tal-ħġieg u tal-mola. Wara jnaddaf il-ħġieg minn xi zejt jew contaminant ieħor. Metodu li wiehed jista' juża huwa li l-ewwel jimsaħ il-ħġieg b'ċarruta niexfa, wara jaqbad ċarruta oħra jew tajjara mċappsa bis-'Surgical Spirit' u jnaddaf il-ħġieg biha. Fl-aħħar jillostra b'ċarruta niexfa. Din il-biċċa xogħol wiehed għandu jagħmilha issa sabiex ikun jista' jnaddaf il-ħġieg aħjar qabel jgħaqqdu u wkoll sabiex malli jgħaqqdu jkollu biss il-marki tas-waba xi jneħhi u mhux dak it-tidlok ta' zejt u ħmieġ li jkollu hekk kif iġibu minghand taż-zebgha.

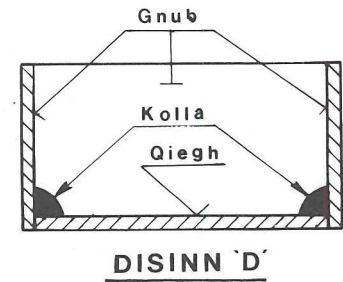
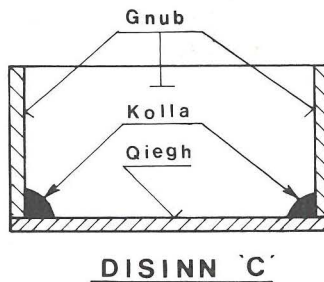
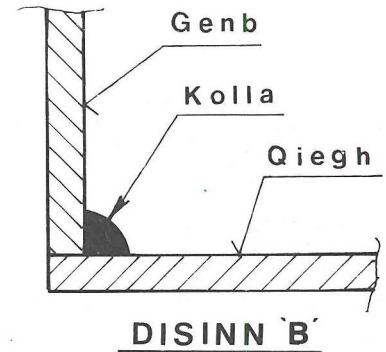
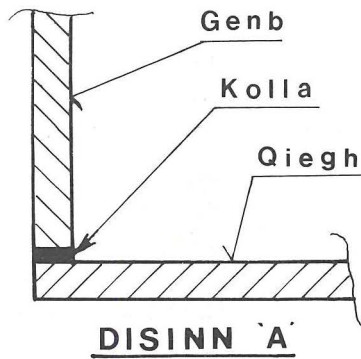

Issa niġu biex nġaqqdu l-ħġieg u niffurmaw l-akkwarju. Nahseb aħjar nagħtikom xi disinni ħfief biex nispjega.

## □ KOLLA U JOINTS

L-ewwelnett irrid ngħid li l-kolla li wiehed għandu juża hija "Silicon Glue". Din il-kolla hija ta' kulur abjad u meta tinxfef issir qisha 'rubber' artab. Il-kolla għandha żewġ funzjonijiet. L-ewwel li taqbad il-ħġieg ma' xulxin, u t-tieni li tissilja. Mela meta wiehed ikun qiegħed juża l-kolla jrid ikun ċert li ma jhallilhiex qtuħ għax inkella l-vaska tagħmel. Hemm ħafna

modi kif wiehed jgħaqqad il-ħġieg ma' xulxin, imma kif tagħmel il-'joint' mod wiehed biss hemm.

Disinn 'A' juri l-mod ħazin u disinn 'B' juri l-mod tajjeb. 'Joint' magħmul bħal disinn 'B' ikun aktar b'saħħtu. Meta wiehed jiġi għall-qiegħ l-aħjar mod kif wiehed jgħaqqdu huwa bħal disinn 'C'. B'dan il-mod jassigura li l-qiegħ ikun catt minn genb sa genb. Jekk wiehed jipprova jgħaqqdu bħal disinn 'D' jista' jagħti l-każ li meta l-kolla tinxfef jinduna li l-akkwarju qiegħed iserrah fuq il-ħġieg tal-genb

• **Ikompli f'pagna 30**

# QTIL WAQT LOGHBA POKER

Kien il-Gimgha, 20 ta' Awissu, 1976, ghal habta tad-9.30 p.m. meta tlett laghba marru bhas-soltu d-dar ta' Domingos Carvalho fi Brampton, Ontario biex jilghabu l-poker. Carvalho infurmahom li r-raba' player Marrey Durrer li kellu 21 sena, kien se jinghaqad jilghab maghhom aktar tard peress li dahal ftit xurban u mar jistrieħ fil-kamra tas-sodda.

Kienu għadew biss ftit minuti meta tlieta minn nies b'wicċhom mgħammad dahlu fuqhom arma-ti b'revolvers u wara li serqulhom il-flus u xi gojjelli li kellhom fuqhom, ordnewlhom jinteddu fl-art. Wara li rabtulhom idnejhom u saqajhom b'habel tan-nylon, wieħed mill-hallelin beda jfittex u jqalleb fil-kxaxen. Carvalho qal lill-hallelin sabiex ma jidhlux fil-kamra tas-sodda għax hemm Durrer u peress li kien xurban, jaf jirrezisti u tigrì xi diżgrazzja. Izda l-hallelin xorta waħda dahlu u wara ftit instema tir ta' pistola. Huma ppanikjaw u telqu jiġru l-barra b'650 dollaru fi flus u l-gojjelli.

Carvalho irnexxielu jinħall u wara li heles lil shabu, hareġ barra jghajjat għall-ghajjut. Giet infurmata l-Pulizija u appena waslu fuq il-post, mill-ewwel bdew jippruvaw jiksbu xi tagħrif minn xi xhieda. Issejhu wkoll xi Pulizija biex jassiguraw li minn gor-residenza fejn saret is-serqa, ma' jidhul u johrog hadd biex ma' tingeridx xi evidenza importanti. Sadanittant, Durrer li kien gie milqut b'tir go rasu, gie mehud l-isptar mitluf minn sensieh.

Hafna mill-girien ta' Carvalho ma' raw u ma' semghu xejn għajr raġel li qal li ra tlett irġiel jiġru, qabzu ċint, qasmu għat-triq tan-naħa l-oħra u harbu b'karozza li kienet qed tistennihom. Huwa ta wkoll id-deskrizzjoni tal-karozza. Dak il-lejl stess saret tfittxija intensiva għall-karozza izda ma' nstabitx.

Għall-habta tal-5.25 a.m. tas-Sibt, 21 ta' Awissu, Durrer miet mingħajr l-anqas biss ma' gie f'sensieh. Mill-awtopsja irrizulta li huwa gie maqtul b'tir ta' revolver go rasu minn distanza fil-qrib.

Il-Pulizija kompliet tagħmel l-

investigazzjonijiet tagħha fejn irnexxielha tikseb tagħrif minn xhud ieħor li dak il-hin inzerta għaddej mit-triq fejn għalkemm ma' setgħa jagħraf lil hadd, semgħa lil wieħed mill-hallelin jghajjat 'Frank'. Għamlu tfittxija madwar ir-residenza fejn gara l-kaz u rnexxielhom isibu habel tan-nylon jixbah hafna 'l dak li rabtu bih lil vittmi u li kien fihom ukoll xi marki tas-swaba. Fid-dar ta' Carvalho sabu wkoll basket li hallew warajhom b'marki tas-swaba ċari. F'karozza li kienet ipparkjata hdejn iċ-ċint sabu marka shiħa ta' pala ta' id li kienet taqbel ma' xi marki li nstabu fid-dar. L-investigazzjonijiet komplew għal gimgha shiħa fejn il-Pulizija interrogaw mijiet ta' xhieda u studjaw bir-reqqa l-marki tas-swaba.

## Arrestati

Fis-27 ta' Awissu, 1976, il-Pulizija ikkonkludew li l-marki tas-swaba li kienu instabu fil-habel tan-nylon kienu ta' Frederick Cadeddu ta' 26 sena minn Niagara Falls, Ontario u marki oħra li kienu nstabu fil-basket li hallew warajhom kienu ta' hu Frederick, jigifieri Frank Cadeddu ta' 21 sena.

Fid-29 ta' Awissu, Frederick u Frank Cadeddu ġew arrestati. Mill-istqarrijiet li għamlu irrizulta li r-raġel l-ieħor li ha sehem fis-serqa kien Stewart English ta' 24 sena minn Orangeville. Irrizulta wkoll li kien hemm involut persuna oħra li għalkemm ma hax sehem fis-serqa, Robert Gorham ta' 26 sena minn Mississauga, kellu sehem kbir fl-ippjanar tagħha. Fl-istqarrijiet qalu wkoll fejn kienu hbew l-armi li kienu serqu minn Niagara Falls xi tmien jew disa' xhur qabel is-

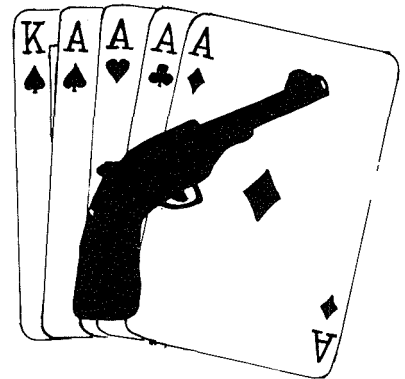

serqa. Mal-erbghin 'exhibit' li nstabu fil-post u fl-inħawi ta' fejn sar id-delitt, intbagħtu e-ċentru tal-Forensic Science ta' Toronto, fejn irrizulta li l-balla li giet sparata waqt is-serqa kienet minn wieħed mir-revolvers rikoverati mill-Pulizija u zewġ xagħriet li kien hemm ma' kalzetta li wzaw biex jagħmdu wiċċhom bihom, kienu ta' Fred Cadeddu.

Mill-investigazzjonijiet li komplew jagħmlu l-Pulizija, irrizultaw dawn il-fatti.

Corham kien jaf li f'dik id-dar jilghabu l-poker għal hafna flus (hafna aktar milli serqu). Gorham, l-aħwa Cadeddu u English ippjanaw din is-serqa bir-reqqa u wieħed mill-ftehim kien li ma' jifthux nar bla bżonn. F'dik il-ġurnata tas-serqa, Gorham ha hsieb jixtri l-habel tan-nylon u kalzetti suwed tan-nisa minn hwienet differenti. Fteħmu wkoll li huwa ma' jieħux sehem fis-serqa minhabba li l-lagħba setgħu jagħrfuh peress li kien midhla ta' dawk l-inħawi.

Għal-habta tad-9.30 p.m. ta' l-10 ta' Awissu, huma dahlu f'dik id-dar u meta raw li sabu biss 650 dollaru hasbu li kien hemm xi flus oħra moħbija. Frank Cadeddu dahal fil-kamra tas-sodda fejn kien hemm Murrey Durrer rieked. Kif dan ta' l-aħħar sema' l-hsejjes, qam maħsud u ntefgħa għal fuq Frank jissielet miegħu. Meta Frederick Cadeddu semgħu l-hsejjes, dahal fil-kamra u spara tir fuq in-naħa ta' wara ta' ras Durrer. Huma ippanikjaw, harbu u hallew warajhom basket. Saqu għal Brampton u mat-triq irmew il-bullets u z-zraben li kienu lebsin. English heba ir-revolvers u l-kalzetti fil-kamra ta' l-imbarazz ta' fejn kien joqgħod. L-aħħar haġa li għamiu

## QTIL WAQT LOGHBA POKER

kienet li qasmu l-Ilus u kulhadd telaq għal rasu.

### Ikkundannati l-ħabs

Fis-27 ta' April, 1977, Frank Caddedu u Stewart English tressqu l-Qorti akkuzati b'kompliċità ta' qtil u wehlu l-massimu ta' 14-il sena ħabs kull wieħed.

Robert Gorham li gie akkuzat b'kompliċità ta' serq gie ikkundannat għal 10 snin ħabs.

Frederick Caddedu deher il-Qorti fil-25 ta' Mejju, 1977, akkuzat bi qtil, gie ikkundannat għal ghomru l-ħabs.

### Irnexxielu jaħrab

Fil-25 ta' Mejju, 1980, Frederick Caddedu irnexxielu jaħrab mill-ħabs ta' Millhaven. Fis-7 ta' Lulju, 1980, huwa ħataf manager ta' Bank mid-dar tiegħu u wara li ħadu b'forza il-bank, seraq 101,000 dollaru. Jumejn wara, Caddedu gie arrestat mid-dar tiegħu fi Niagara Falls, Ontario. Huwa wehel 19-il sena ħabs oħra fuq dik li digà kellu għall-ghomru.

## FIREARMS

● *continued from page 9*

usual Webley target sights. In all other respects it was unchanged from the standard model.

### •38 MODEL, 1901

Concurrently with the .455 model, a .38 version was produced, though from the scarcity of the remaining specimens, it would seem that few were made. As far as possible, the components of the .455 were used, but a new cylinder had to be made, and this was produced in an unusual eight-chambered configuration. This required a special design of rotating slot, and at the same time, the opportunity was taken to alter the design of the safety catch. These .38 Fosberys shot well and made a name for themselves in the Bisley meeting of 1901.

### •455 MODEL, 1902

Some minor changes were made for the 1902 models, the

chief ones being to make side plates removable on the frame, and to change the cylinder flutes from being at the back of the cylinder to the front. A few were produced with the Pryse flat-top barrel, and some target shooters preferred to remove the safety. Otherwise there is little to differentiate these from those of the previous year.

**By this article we have covered all the Webley revolvers. As many of you are aware, Webley & Scott have also made semi auto pistols and we are also bound to cover these in the next issue of IL-PULIZIJA, before proceeding onto other makers.**

**We would like to invite our readers or other interested Police Personnel to contact the editor in writing and suggest which make they would like us to treat in the forthcoming issues, obviously after the completion of the Webley Series.**

## L-AKKWARJU

(Ikompili minn paġna 27')

minflok fuq il-qiegh. Dan jirrizulta f'pressjoni żejda fuq il-qiegh.

Niġu issa għall-ġenb. Hemm żewġ metodi kif wiehed jgħaqqad il-ġnub ma' xulxin. Disinn 'E' juri l-ewwel mod u disinn 'F' juri l-mod l-ieħor. Id-differenza bejn disinn 'E' u 'F' hija li l-joint ta' disinn 'F' huwa aktar b'saħħtu. Biss wiehed irid joqgħod attent li ma jagħmilx ħafna kolla ma' barra, sabiex meta jiġi biex jaħdem il-'Frame' ikun jista' jpoġġieħ sewwa. Disinn 'G' juri dan li qieghed ngħid. Hemm żewġ materjali tajbin li wiehed jista' jażer - 'angle' ta' l-aluminium', jew angle tal-'plastik'. It-tieni sabiħ u faċli biex jitwawħal flimkien. Mela s'issa tgħallimna kif ngħaqqdu l-Vaska. L-aħħar ħaġa li rrid inzid ma' dak li digà għedt hija li wiehed mhux jaqbad jgħaqqad il-qiegh mal-ġenb, imbagħad wara jara kif se jkompili. Irid jiddeciedi mill-ewwel kif sejjer jgħaqqdu flimkien qabel

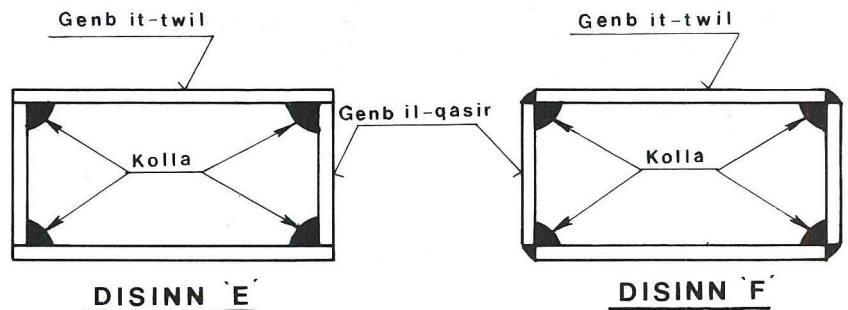

ma jaqbad il-kolla b'idejh. Meta l-vaska tkun lesta rridu nħalluha għal jumejn sabiex ir-riħa qawwija tal-kolla tmur.

### □ VENTILAZZJONI ADEKWATA

Importanti li naraw f'liema kamra jpoġġi l-vaska sakemm tinxf għax kif digà għedt, il-kolla tarmi riħa qawwija ħafna u tista' tkun ta' ħsara. Għalhekk l-aħjar ħaġa hija li wiehed għandu jarma l-vaska u jħalliha tinxf f'post b'ventilazzjoni adekwata, bħal ngħidu aħna, f'garaxx bilbieb miftuħ, jew f'xi bitha, jew fuq bejt.

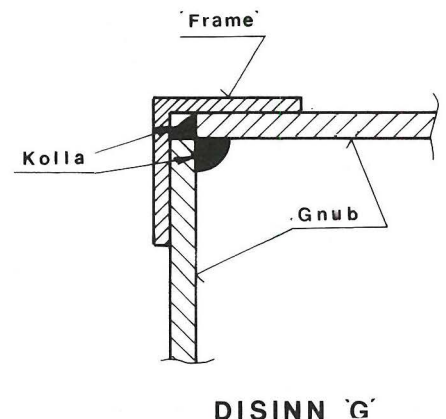

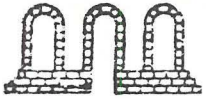

# ATTARD BROS. CO. LTD.

TA' QALI - Tel: 486980/621456



## BEJGH U ĠARR TA' MATERJAL

- |  |  |
|--|--|
| <input type="checkbox"/> Qatran tal-filata           | <input type="checkbox"/> Siment                        |
| <input type="checkbox"/> Waterproofing membrane      | <input type="checkbox"/> Ġarr ta' torba                |
| <input type="checkbox"/> Xibka mwassla bil-'high-up' | <input type="checkbox"/> Taħmil ta' plots              |
| <input type="checkbox"/> Vireg u stirrups            | <input type="checkbox"/> Kiri ta' cranes u scaffolding |
| <input type="checkbox"/> Katusi u fittings           |  |

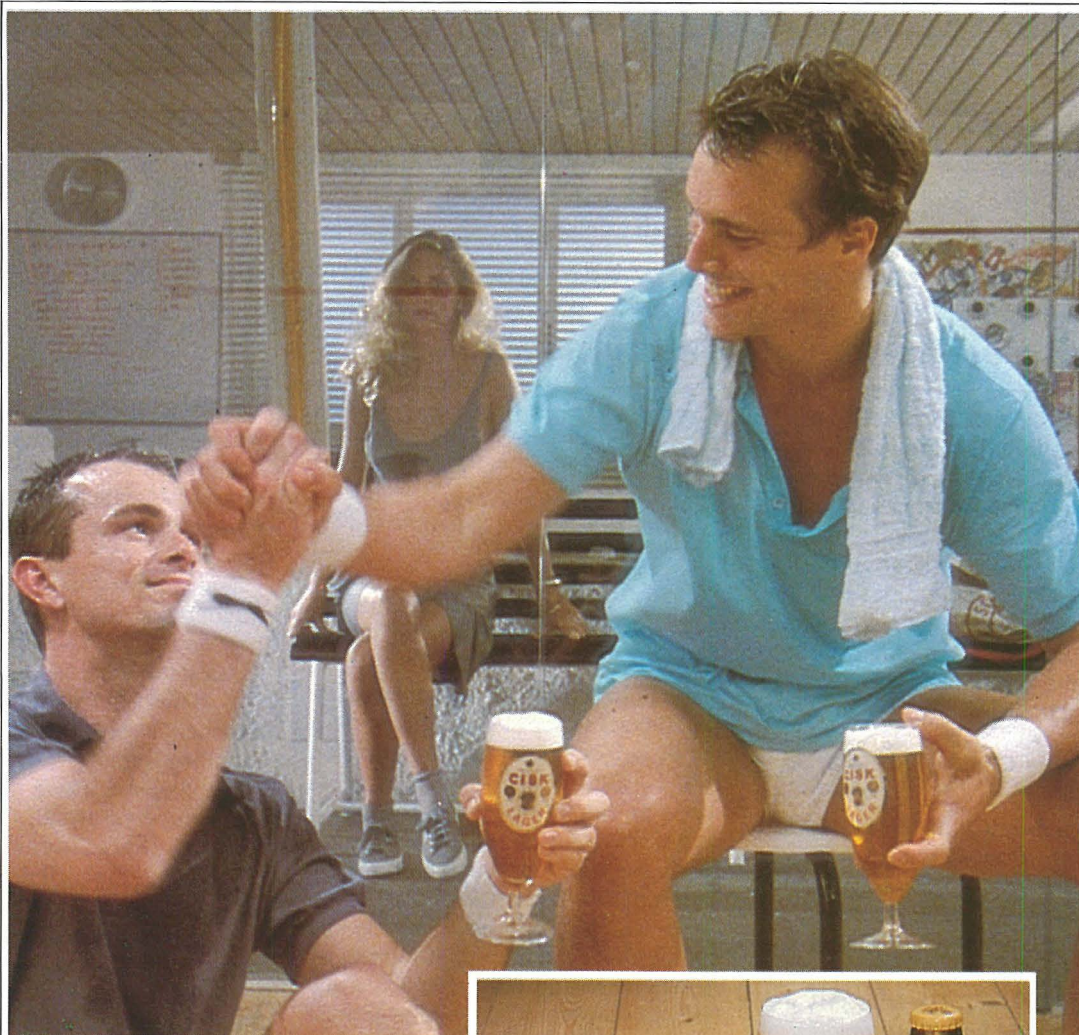

**CISK**  
...a taste  
of success.

A quality beer from **FARSONS**



# Admissibility of Post-Hypnotic Testimony

By **KIMBERLEY A. KINGSTON**  
Special Agent • FBI Academy • Legal Counsel Division  
Federal Bureau of Investigation • Quantico, VA

**PART IV**

**“... law enforcement officers should be selective in their use of hypnosis and should follow procedures that grant them the greatest likelihood of admissibility.”**

Today, several courts still hold to the proposition that the possible effects of hypersuggestion, hypercompliance, and confabulation impact on the weight, not the admissibility, of the testimony of previously hypnotized witnesses. These courts assume that “skillful cross-examination will enable the jury to evaluate the effects of hypnosis on the witness and the credibility of his testimony.”<sup>21</sup>

## Admissibility Contingent Upon Reliability

Several State appellate courts since *Harding* have created a second category of cases on this issue by rejecting *Harding's* per se admissible standard, and instead, adopting a rule of limited admissibility.<sup>22</sup> Court decisions that fall into this category are more concerned with the problems inherent in the hypnotic process and hold that the admissibility of post-hypnotic testimony is contingent upon a showing that the hypnotically refreshed recall is reliable. While these courts agree that the key to admissibility of post-hypnotic testimony is reliability, the methods prescribed for demonstrating such reliability vary greatly by jurisdiction.

Some jurisdictions have embraced a very elementary test of reliability that requires the party proposing the testimony of a previously hypnotized witness to show that the testimony is based on the witness' independent recall and is not merely the product of the hypnotic process. Conceivably, this burden could be met by demonstrating a consonance between the witness' pre- and post-hypnotic statements, corroboration of the witness' statements made under hypnosis, or merely by establishing the opportunity of the

*Law enforcement officers of other than Federal Jurisdiction who are interested in any legal issue discussed in this article should consult their legal adviser. Some Police procedures ruled permissible under Federal constitutional law are of questionable legality under State Law or are not permitted by law or are not permitted at all.*

witness to observe the events which he purports to recall under hypnosis.<sup>23</sup> Other jurisdictions apply a balancing test<sup>24</sup> which measures the probative value of the post-hypnotic testimony and weighs it against the “danger of unfair prejudice, confusion of issues, or misleading the finder of fact.”<sup>25</sup>

However, a majority of courts that subscribe to the limited admissibility rule have shifted their attention away from the proffered post-hypnotic testimony and focus, instead, on the hypnotic process itself. Typically, these courts attempt to insure the reliability of post-hypnotic recall by imposing procedural safeguards which must be strictly adhered to during the hypnotic session. Although differing slightly from jurisdiction to jurisdiction, a majority of these safeguards have been adapted from suggestions made by Dr. Martin Orne,<sup>26</sup> an expert in hypnosis, and are, therefore, fundamentally quite similar.

Dr. Orne's suggestions were first introduced in the 1981 New Jersey Supreme Court case of *State v. Hurd*.<sup>27</sup> In this case, defendant Hurd was arrested and charged with assault with intent to kill when the victim of the assault identified Hurd as her assailant. The victim, Hurd's ex-wife, informed investigators that on the evening of the attack, she was asleep in the bedroom of her ground floor apartment when

someone reached through the window and stabbed her numerous times. Although she was unable to identify her attacker immediately after the incident, the victim asked the police to “check out” her former husband. Later, the victim was informed that her current husband, David Sell, and her former husband, Paul Hurd, were the primary suspects in the case.

The victim then agreed to undergo hypnosis in an attempt to refresh her memory. While under hypnosis, the victim began to relive the incident and became hysterical. When asked whether the assailant was her ex-husband, the victim responded affirmatively.

After she was brought out of the hypnotic trance, the victim expressed mistrust about her identification of Hurd. However, investigators encouraged her to vindicate her current husband by making a formal identification of Hurd. Consequently, the victim gave a statement to police identifying Paul Hurd as her assailant.

## Footnotes

<sup>21</sup>*State v. Hurd*, 432 A. 2d 86, 91 (N.J. 1981).

<sup>22</sup>See, e.g., *State v. Contreras*, 674 P. 2d 792 (Alaska App. 1983); *State v. Iwakiri*, 682 P. 2d 571 (Idaho 1984); *People v. Cohoon*, 457 N.W. 2d 998 (Ill. App. 1984); *Gentry v. State*, 471 N.E. 2d 263 (Ind. 1984); *Strong v. State*, 435 N.E. 2d 969 (Ind. 1982); *State v. Luther*, 663 P. 2d 1261 (Or. App. 1983); *State v. Jorgensen*, 492 P. 2d 312 (Or. App. 1971); *Walters v. State*, 680 S.W. 2d 60 (Tex. App. 1984); *Zani v. State*, 679 S.W. 2d 144 (Tex. App. 1984); *Hopkins v. Com.*, 337 S.E. 2d 264 (Va. 1985).

<sup>23</sup>See generally, Plotkin, *supra* note 4, 184-85. See also, *State v. Contreras*, 674 P. 2d 792 (Alaska App. 1983); *People v. Cohoon*, 457 N.E. 2d 998 (Ill. App. 1984); *Gentry v. State*, 471 N.E. 2d 263 (Ind. 1984); *Strong v. State*, 435 N.E. 2d 969 (Ind. 1984); *Walters v. State*, 680 S.W. 2d 60 (Tex. App. 1984); *Hopkins v. Com.*, 337 S.E. 2d 264 (Va. 1985).

<sup>24</sup>See, e.g., *United States v. Valdez*, 722 F.2d 1196 (5th Cir. 1984); *United States v. Valdez*, 722 F.2d 1196 (5th Cir. 1984); *State v. Iwakiri*, 682 P. 2d 571 (Idaho 1984).

<sup>25</sup>Plotkin, *supra* note 4, at 185.

<sup>26</sup>For a resume of Dr. Orne's qualifications, see *supra* note 10, at 1288, n. 6.

<sup>27</sup>432 A. 2d 86 (N.J. 1981).



**FOOTBALL**

**League tal-Gvern u Korpi Parastatali 1986-87**

□ FL-AHHAR ħarġa ta' dan il-magazine tajtkom rapport dwar l-ewwel logħba tat-team tal-Pulizija fil-league tal-Gvern/Korpi Parastatali (1986/87). Wara din il-logħba t-team tal-Pulizija kompli fit-triq it-tajba meta għal-logħbiet ta' wara baqa' juri progress biex spiċċa l-league fl-ewwel post tal-klassifika flimkien mat-team tal-A.F.M. b'għaxar punti kull wiehed biż-żewġ teams jtilfu logħba kull wiehed.

It-team tal-Pulizija kellu dawn ir-riżultati:-

Pulizija vs Mid-Med Bank	3-2
Pulizija vs M.A.F.	4-1
Pulizija vs Air Malta	2-1
Pulizija vs A.F.M.	2-1
Pulizija vs Shipbuilding	1-4
Pulizija vs M.D.C.	1-0

Iż-żewġ teams dak tal-Pulizija u tal-A.F.M. ġew promossi għall-Ewwel Diviżjoni. Fid-decider li saret nhar 1-10.3.87 l-A.F.M. għelbu lit-team tal-Pulizija 3-0 biex ġew dikjarati Champions tat-Tieni Diviżjoni.

**Rapport ta' żewġ logħbiet**

**Pulizija vs A.F.M. 2-1**

**Formazzjonijiet:**

PULIZIJA – PC 217 P. Dibbon, PC 959 G. Grech, PC 559 J. Mulvaney, PS 496 G. Borg, PC 607 J. Camilleri, PS 567 T. Bajada, PC 366 E. Psaila, PC 683 M. Caruana, PC 811 V. Busuttil, PC 610 L. Grima, PC 601 F. Zammit. RES: PC 874 P. Zammit, PC 1119 P. De Raffaele, PS 509 J. Lentini, PC 712 M. Magri.

A.F.M. – V. Bonnici, A. Said, J. Fenech, A. Borg, C. Micallef, M. Grima, S. Scerri, T. Galea, M. Monreal, A. Grech, V. Grech. RES: C. Sammut, G. Duca, J. Farrugia, J. Goodlip.

Wara t-telfa kontra l-M.D.C. it-team tal-Pulizija ħtiegħu jirbaħ din il-logħba biex jibqa' biċ-ċans għall-promozzjoni fl-Ewwel Diviżjoni. It-team l-iehor f'din il-logħba dan tal-A.F.M. huwa wkoll kandidat għall-promozzjoni għaliex qabel din il-logħba kellu żewġ rebħiet u draw minn tliet partiti.

L-ewwel half ta' din il-partita kien bilanċjat biż-żewġ teamijiet jiddefendu tajjeb kull attakk avversarju bid-difiża avversarja

jiddominaw fuq l-attakkanti, biż-żewġ goalers f'tit li xejn ikollhom x'jagħmlu fil-lasti rispettivi. Għalkemm iż-żewġ teams għamlu minn kollox biex jifih u l-iscore l-ewwel taqsima għalqet mingħajr goal bit-team tal-Pulizija jersaq vicin tal-goal meta f'tit minuti mill-mistrieħ xutt cross ta' P.C. 610 L. Grima minn fuq ix-xellug bil-ballun jigi għand P.S. 567 T. Bajada li bir-ras tefa' kemm kemm barra.

Għat-tieni taqsima fit-team tal-Pulizija daħal P.C. 1119 P. De Raffaele flok PC. 583 M. Caruana u fit-team tal-A.F.M. C. Sammut daħal flok V. Bonnici bhala goaler. Wara biss hames minuti logħob it-team tal-Pulizija fetaħ l-iscore meta minn corner PC 610 L. Grima qassam lil PC 601 F. Zammit li minn barra l-kaxxa l-kbira fajjar xutt fir-rokna tax-xibka bil-goaler C. Sammut ikun f'tit tard fl-attentat tiegħu biex isalva.

Wara dan il-goal it-team tal-A.F.M. għamel reazzjon immedjata u wara biss tliet minuti ġab l-iscore indaqs permezz tal-player ħabrieqi tagħhom C. Micallef li wara li rċieva pass fin-nofs fajjar xutt lejn il-last bil-ballun jgħaddi minn taħt il-goaler PC 217 P. Dibbon u jispiċċa fix-xibka. Il-logħba kompliet aktar aggressiva biż-żewġ naħat jippruvaw jiksbu l-goal tarrebha u f'żewġ okkażjonijiet iż-żewġ teams kellhom fejn iżidu l-iscore.

L-ewwel ċans gie għand tal-Pulizija meta PC 1119 P. De Raffaele rċieva pass fit-tul u wara li avvanza waħdu ra x-xutt finali tiegħu jgħaddi kemm kemm barra. F'tit wara gie ċ-ċans l-iehor din id-darba għat-team

tal-A.F.M. meta V. Grech ra x-xutt finali tiegħu jaħbat mal-last u jispiċċa barra. Il-goal tarrebha għat-team tal-Pulizija wasal fl-ghoxrin minuta meta wara ħarba ta' PS 567 T. Bajada fuq il-lemin qassam ballun għannofs lejn PC 1119 P. De Raffaele li sammar il-ballun fir-rokna ta' fuq tal-last. Wara dan il-goal it-team tal-A.F.M. daħhal lil J. Farrugia flok M. Monreal. Il-logħba kompliet bit-team tal-Pulizija jiddefendi l-vantagg li kellu sat-tmiem u jsaħħaħ postu f'ras il-klassifika tat-Tieni Diviżjoni tal-League tal-Gvern/Korpi Parastatali.

**Pulizija vs M.A.F. 4-1**

**Formazzjonijiet:**

PULIZIJA – PC 217 P. Dibbon, PC 617 T. Camilleri, PC 559 J. Mulvaney, PS 496 G. Borg, PC 314 J. Grima, PC 607 J. Camilleri, PS 567 T. Bajada, PC 287 R. Aquilina, PC 1119 P. De Raffaele, PC 874 P. Zammit, PC 811 V. Busuttil. RES: PC 1263 S. Cosby, PC 601 F. Zammit, PC 600 V. Upton, PS 509 J. Lentini, PC 610 L. Grima.

M.A.F. – Paul Muscat, Ray Muscat Terribile, Edmond Bartolo, Joe Borg, Ray Xuereb, Jimmy Briffa, Jesmond Cardona, Julian Micallef, Mario Salerno, Stephen Gatt, Alex Muscat. RES: Frank Ciantar, Kevin Haber.

Din il-logħba kienet ferm importanti għall-kumpliment tal-league tat-Tieni Diviżjoni għaliex dawn iż-żewġ teamijiet kienu fost il-favoriti għar-rebħ tal-league. Iż-żewġ teamijiet kienu gejjin minn rebħa fl-ewwel logħba tagħhom f'dan il-league u għalhekk telta kienet tkisser it-tamiet kolha għal dawn iż-żewġ teamijiet.

# SPORTS

Għal din il-logħba ż-żewġ teamijiet nizlu bl-aħjar elementi fil-pussess tagħhom u mill-bidu dehret li ser tkun kumbattuta. Wara biss hames minuti il-goaler tal-M.A.F. Paul Muscat wegġa' idu f'daħla ma' avversarju u għalkemm kompli l-logħba deher li ma giex f'sikkto. Ftit wara dan l-incident wasal l-ewwel goal għat-team tal-Pulizija meta P.C. 811 V. Busuttil għadda l-ballun lil PS 567 T. Bajada li bir-ras qabbez il-ballun lejn PC 287 R. Aquilina li b'xutt mill-ewwel għeleb lil goaler Paul Muscat li deher għadu jhoss l-uġiegh fuq idu. Il-logħba kompliet biż-żewġ naħat jipprovaw jikkontrollaw lil xulxin bit-team tal-Pulizija jkompli jkun xi ftit aggressiv aktar mill-avversarji u proprju fit-30 minuta attentat tajjeb ta' PS 567

T. Bajada gie salvat f'corner mill-goaler Paul Muscat.

Għat-tieni taqsima t-team tal-M.A.F. biddel lill-goaler Paul Muscat ma' l-attakkant Stephen Gatt u daħal bħala sostitut Kevin Haber. F'din it-taqsima t-team tal-M.A.F. hareg għal goal kmieni biex jipprova jsalva l-logħba u fil-5 minuta gie çans tajjeb għat-team tal-M.A.F. li jgħib id-draw meta minn xutt b'saħħtu ta' Mario Salerno, PC 217 P. Dibbon fil-lastat team tal-Pulizija, ma zammx u PC 314 J. Grima lahaq fil-hin u tajjar il-ballun f'corner biex evita goal çert. Fis-7 minuta wasal it-tieni goal għat-team tal-Pulizija meta PC 607 J. Camilleri ta' pass fit-tul lil PC 1119 P. De Raffaele li wara li avvanza fajjar xutt in-naħa l-oħra tal-goaler.

Ftit wara dan il-goal it-team tal-M.A.F. reġa' daħal fil-logħba meta xutt barra l-kaxxa ta' Jesmond Caruana għeleb għal kollox lill-goaler PC 217 P. Dibbon. Wara din il-ħasda t-team tal-Pulizija beda joqgħod aktar attent għal avversarji u ntefa aktar biex jiddefendi l-goal vantaġġ u jibni kontrattakki mibnija fuq PS 567 T. Bajada. F'waħda minn dawn il-kontrattakki t-team tal-Pulizija zied l-iscore meta PS 567 T. Bajada ħarab lill-avversarju dirett tiegħu u wara li avvanza fajjar xutt minn barra l-kaxxa l-kbira li għeleb għal kollox lill-goaler tal-M.A.F. Fl-20 minuta wasal il-goal l-iehor għat-team tal-Pulizija meta P.C. 811 V. Busuttil qassam fil-qosor il PS 567 T. Bajada li b'finta għeleb lill-avversarju u gie waħdu quddiem il-goaler u poggja l-ballun fir-rokna tax-xibka, biex ta rebħa meritata ta' 4-1 lit-team tal-Pulizija.

## KOTBA LI JINSABU GĦALL-BEJGĦ FIL-LIBRERIJA TAL-PULIZIJA

### KODIĊI KRIMINALI

Lm2 Membri tal-Korp

### KODIĊI TA' LIĠIJET TAL-PULIZIJA

Lm2 Membri tal-Korp

### KODIĊI TA' ORGANIZZAZZJONI U PROĊEDURA ĊIVILI

Lm3.50 Membri tal-Korp

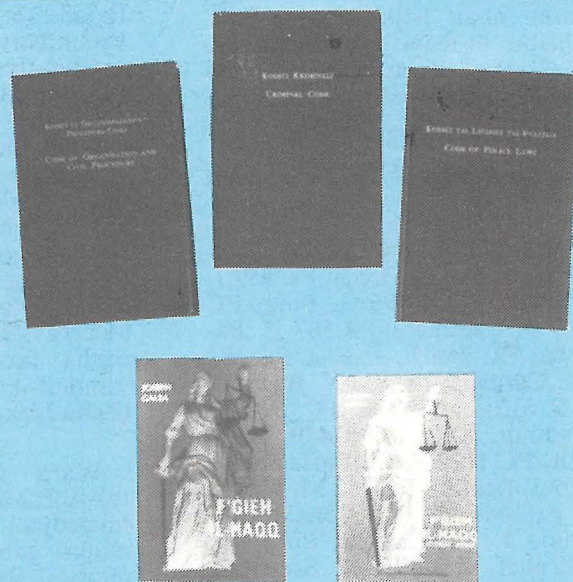

### F'ĠIEH IL-HAQQ — Book I

Lm1 Membri tal-Korp

### F'ĠIEH IL-HAQQ — Book II

Lm1 Membri tal-Korp

### Gabra ta' Appelli Kriminali (Sede Inferjuri) 1976-1978.

(Magħżulin u miġburin mill-Onor. Imħallef  
Joseph A. Filletti B.A., LL.D. għall-prezz ta'  
Lm2.80c.

A close-up, low-angle shot of the side of an Air Malta aircraft. The top half of the image shows a clear blue sky with scattered white clouds. The middle section features the aircraft's livery: a white upper band with the word "AIRMALTA" in red and blue lettering, a dark blue band with a row of oval windows outlined in white, and a red band below. The bottom section shows the dark, riveted metal of the fuselage.

**AIRMALTA**

**We promise you  
a warm welcome.**

# Open a Current Account with the Bank of Valletta

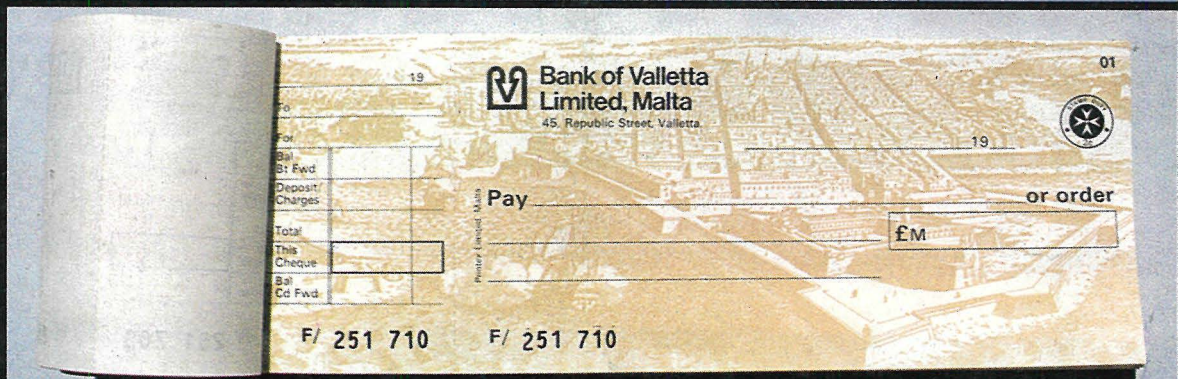

A current account with the Bank of Valletta saves so much time and trouble.

The Bank of Valletta is its only Bank in Malta that does not charge Ledger Fees.

Your money is safe and the signing of a cheque neatly covers bills and purchases.

For your convenience and safety –

Open a current account with the Bank of Valletta.



**Bank of Valletta Limited, Malta**

*For a Better Service*