

## Maturation of critical technologies for the DEMO balance of plant systems

L. Barucca<sup>a,\*</sup>, W. Hering<sup>b</sup>, S. Perez Martin<sup>b</sup>, E. Bubelis<sup>b</sup>, A. Del Nevo<sup>c</sup>, M. Di Prinzio<sup>a</sup>, M. Caramello<sup>a</sup>, A. D'Alessandro<sup>d</sup>, A. Tarallo<sup>e</sup>, E. Vallone<sup>f</sup>, I. Moscato<sup>f</sup>, A. Quartararo<sup>f</sup>, S D'amico<sup>b</sup>, F. Giannetti<sup>g</sup>, P. Lorusso<sup>g</sup>, V. Narcisi<sup>g</sup>, C. Ciurluini<sup>g</sup>, M.J. Montes Pita<sup>h</sup>, C. Sánchez<sup>h</sup>, A. Rovira<sup>h</sup>, D. Santana<sup>i</sup>, P. Gonzales<sup>i</sup>, R. Barbero<sup>h</sup>, M. Zaupa<sup>l</sup>, M. Szogradi<sup>m</sup>, S. Normann<sup>m</sup>, M. Vaananen<sup>n</sup>, J. Ylatalo<sup>m</sup>, M. Lewandowska<sup>o</sup>, L. Malinowski<sup>o</sup>, E. Martelli<sup>p</sup>, A. Froio<sup>q</sup>, P. Arena<sup>f</sup>, A. Tincani<sup>c</sup>

<sup>a</sup> Ansaldo Nucleare, Via N. Lorenzi 8, Genova 16152, Italy

<sup>b</sup> KIT, Hermann-von-Helmholtz-Platz 1, Eggenstein-Leopoldshafen 76344, Germany

<sup>c</sup> ENEA C.R. Brasimone, Camugnano I-40032, Italy

<sup>d</sup> Ansaldo Energia, Via N. Lorenzi 8, Genova 16152, Italy

<sup>e</sup> CREATE Consortium, Università di Napoli Federico II, Via Claudio 21, Napoli 80125, Italy

<sup>f</sup> Department of Engineering, University of Palermo, Viale delle Scienze, Ed. 6, Palermo 90128, Italy

<sup>g</sup> DIAEE, Sapienza University of Rome, Corso Vittorio Emanuele II, 244, Roma 00186, Italy

<sup>h</sup> Universidad Nacional de Educación a Distancia (UNED), Calle de Bravo Murillo 38, Madrid 28015, Spain

<sup>i</sup> U3CM, Universidad de Carlos III de Madrid, Calle Madrid, 126, Getafe, Madrid 28903, Spain

<sup>l</sup> Consorzio RFX, Corso Stati Uniti, 4, Padova 35127, Italy

<sup>m</sup> VTT Technical Research Centre of Finland Ltd, Kivimiehentie 3, Espoo, Finland

<sup>n</sup> Fortum, Keilalahdentie 2-4, Espoo 02150, Finland

<sup>o</sup> West Pomeranian University of Technology, Szczecin 70-310, Poland

<sup>p</sup> ENEA C.R. Frascati, Frascati 00044, Italy

<sup>q</sup> NEMO Group, Dipartimento Energia, Politecnico di Torino, Torino 10129, Italy

### ARTICLE INFO

#### Keywords:

DEMO  
Balance of plant  
WCLL BB  
HCPB BB  
Steam generator  
Power conversion system

### ABSTRACT

The Pre-Concept Design (PCD) of the Balance of Plant (BoP) systems of the EU-DEMO power plant is described in this paper for both breeding blanket (BB) concepts under assessment, namely the Water Cooled Lithium Lead (WCLL) BB and the Helium Cooled Pebble Bed (HCPB) BB. Moreover, the results of a preliminary evaluation of a number of BoP variants are discussed.

This paper outlines the steps of the BoP design development, highlighting the project objectives and the strategy for their achievement under the very challenging requirements which include, among others, the intermittent nature of the DEMO plasma heat source.

The main achievements during the PCD Phase will be reported together with the development plan for the Concept Design (CD) Phase to reach a mature (feasible) BoP concept for DEMO.

### 1. Introduction

The Balance of Plant (BoP) is a key system of the European DEMONstration Fusion Power Plant (EU DEMO), to come in operation around in the middle of this century with the main aim of demonstrating the production of few hundred MWs of net electricity [1]. The adopted design approach takes into account the Nuclear Power Plant (NPP) experience and the lessons learnt from ITER and Generation IV with the

objective of a feasible and easy licensing for construction and operation and an acceptable technical availability of the plant [2]. This aspect deeply involves BoP design whose safe and reliable operation is of great importance for the success of the project.

The purpose of this paper is to provide an overview of the Pre-Concept Design (PCD) activity outcomes for the DEMO BoP for the Water Cooled Lithium Lead (WCLL) and the Helium Cooled Pebble Bed (HCPB) EU BB concepts performed by the Work Package WPBoP.

\* Corresponding author.

E-mail address: [luciana.barucca@ann.ansaldoenergia.com](mailto:luciana.barucca@ann.ansaldoenergia.com) (L. Barucca).

<https://doi.org/10.1016/j.fusengdes.2022.113096>

Received 6 August 2021; Received in revised form 14 February 2022; Accepted 15 March 2022

Available online 4 April 2022

0920-3796/© 2022 The Authors. Published by Elsevier B.V. This is an open access article under the CC BY license (<http://creativecommons.org/licenses/by/4.0/>).

Attention is focussed on the status of maturity of technologies and technical solutions as well as the pending issues and development plan.

Section 2 introduces the main objectives and challenges of the BoP design. Section 3 describes the investigated BoP variants and the preliminary down-selection.

Sections 4 and 5 are devoted to the detailed design description of the assumed reference variants, respectively the WCLL Direct Coupling Design with Small Energy Storage and the HCPB Indirect Coupling Design. Furthermore, these sections provide information on the variant feasibility and reliability assessment as well as the preliminary cost evaluation.

Finally, Section 6 provides some highlights of the plan to overcome the open issues and technological challenges in the Concept Design (CD) Phase to reach a mature (feasible) DEMO BoP concept.

## 2. The EU-DEMO BoP: overview, objectives and challenges

The BoP consists of a group of sub-systems devoted to the extraction of the pulsed thermal power generated by the plasma and deposited in the Breeding Blanket (BB) [3], Divertor [4] and Vacuum Vessel (VV) [5] and a Power Conversion System (PCS) that converts the heat extracted from the plant heat sources into electrical power to be delivered to the grid via the turbo-generator group [6,7].

An overview of the systems belonging to the reference BoP configurations of both WCLL and HCPB blanket technologies is shown in Figs. 1 and 2 (see also Section 3.1.1 and 3.1.2 for more details), respectively.

The simplified process flow diagram of the HCPB Indirect Coupling Design BoP and that of the WCLL Direct Coupling Design BoP are shown respectively in Figs. 1 and 5 of reference [1].

The main power transfer occurs along the path that includes the Breeding Blanket Primary Heat Transport System (BB PHTS) operated with water or helium, the Intermediate Heat Transport System (IHTS, a molten salt circuit), when present, and the PCS. Three water-cooled systems complete the PHTSs, two for Divertor, intended to cool the Divertor Plasma Facing Components (PFC) and the Cassette Bodies (i.e. divertor cassettes PHTS, divertor PFC PHTS) and one for the Vacuum Vessel (VV PHTS), transferring power to the PCS feed-water line through their integrated Heat exchangers (HXs). Relevant design and architecture data for WCLL and HCPB reference configurations are reported in Table 1, together with those referring to a large fission Nuclear Power Plant (the European Pressurized Reactor - EPR).

From the comparison, it can be observed how large and complex are

BoP subsystems (especially the PHTSs) compared to Nuclear Power Plants (NPP). This applies, in particular, to the needed number of cooling loops, their length and the coolant inventory involved. These features represent a challenge for the BoP development and are determined by the: magnitude of DEMO thermal power, Tokamak size, different coolants and coolant requirements imposed by the In-Vessel heat sources, integration constraints and safety requirements.

In addition, unlike conventional NPPs, DEMO is characterized by a pulsed operation. In fact, the DEMO duty cycle foresees a continuous sequence of two main phases, (see Fig. 3), connected by two transitional phases. In particular, the plasma ramps up within about 100 s bringing its power from zero to the nominal value of around  $2 \text{ GW}_{\text{th}}$  [1]. When the full power level is reached, this condition is kept for around 2 h (pulse phase). Then, a ramp-down of about 100 s leads the system into the dwell phase, which lasts 10 min and where almost no power is generated (the decay heat 1 s after shut-down is around 2% of the nominal power). Fig. 3 shows Demo Power profile with pulse and dwell time periods.

Clearly, this operation mode represents an important challenge for the feasibility of the BoP, which needs a robust design to cope with the thermal and mechanical loads caused by the frequent transients while guaranteeing its safe and reliable operation.

## 3. The BoP variants as risk mitigation strategy

Several variants have been studied for both the WCLL and HCPB BoP, assessing advantages, drawbacks and potential showstoppers, in the attempt to down-select the best options and to achieve a preliminary definition of the reference configuration for the DEMO plant.

In general, the development of the variants for both WCLL and HCPB concepts has been carried out taking into account the following high level design guidelines: i) to provide continuous operation avoiding disconnection from the electrical grid while entering in dwell phase; ii) to limit the impact of frequent temperature transients to the components of the BoP systems; iii) to use at the maximum extent proven technologies; iv) to consider to the conversion cycle efficiency; v) to consider to the costs.

### 3.1. Investigated variants [1,8]

Two design concepts have been investigated for the conversion of thermal power to electrical power: direct or indirect. The BoP “direct” concept consists of an architecture where the PCS is thermally connected to the BB PHTS which adopts provisions to mitigate the negative impact

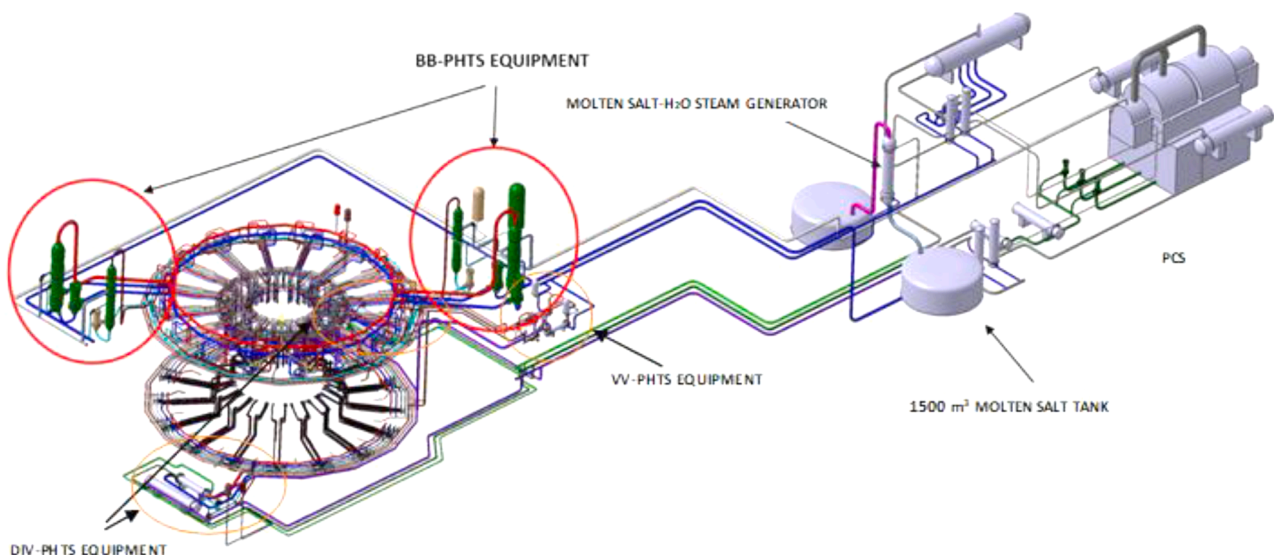

Fig. 1.. WCLL BoP reference configuration: direct coupling design with small energy storage system, 3D CAD model.

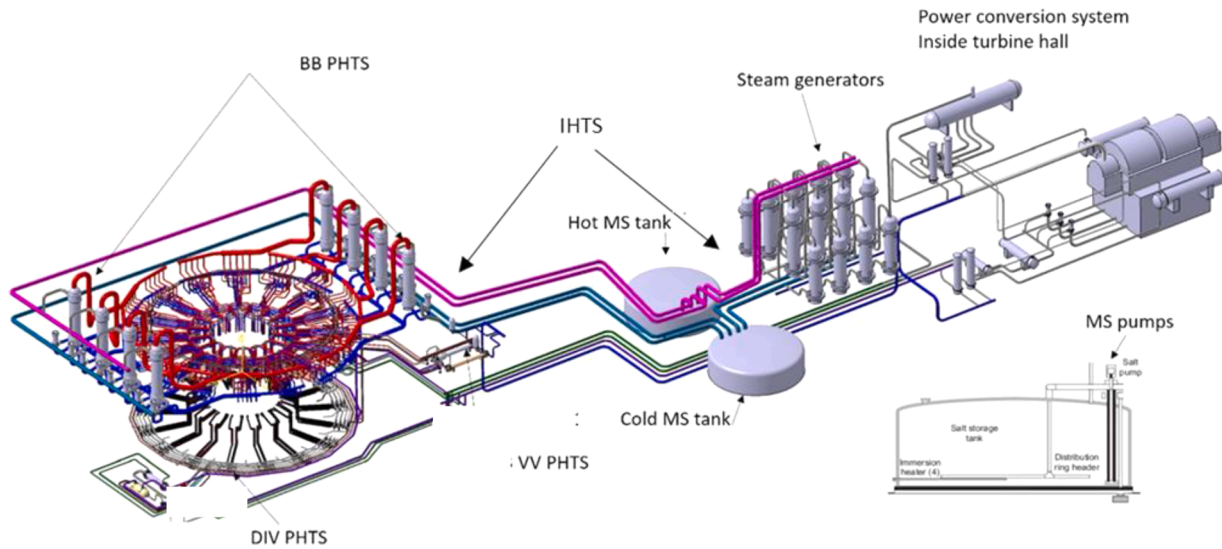

Fig. 2.. HCBP BoP reference configuration: indirect coupling design, 3D CAD Model.

of the plasma pulsed thermal power transferred by the BB PHTS on its components. The BoP “indirect” concept is an architecture which thermally decouples the PCS from the BB PHTS through the use of an IHTS. The IHTS is equipped with an Energy Storage System (ESS) that, buffering energy in pulse for dwell operation, smooths the intermittent generated power profile transmitted to the PCS itself. Depending on ESS size, PCS operation is enabled up to a roughly constant steam load and an almost constant electrical power output to the grid in both pulse and dwell phases. Taking into account this consideration, two functional groups of BoP variants [1], have been investigated: (i) Direct Coupling Design options with the presence of an additional energy source, which may be a small ESS or an auxiliary boiler, that could feed a small steam flow to the Steam Turbine (ST) so to keep synchronized the electric generator to the grid during dwell period and (ii) Indirect Coupling Design options.

It is worth noting that if “pulsed” PCS is defined as that PCS characterized by a marked trapezoidal profile of the power exchanged with DEMO heat transfer systems - Fig. 3 -, it can be stated that all the BOP variants of Direct type and of Indirect type - operating at low load in dwell - belong to this category. In case of BOP Indirect architecture operating at almost constant load in pulse and in dwell, the PCS can be defined as “not pulsed”.

The following sections briefly describe the investigated variants for WCLL and HCPB BoP concepts. The detail of the variants assessment can be found in [1] and [8] where a refinement of the variant ranking tables for comparison and down-selection is reported.

### 3.1.1. WCLL BoP variants

As detailed in Refs. [1] and [8], three main WCLL BoP variants have been conceived: two Direct Coupling Designs (DCD), consisting of a direct configuration with a small ESS and a direct configuration with an AUXiliary Boiler (AUXB) and one Indirect Coupling Design (ICD), consisting of an indirect configuration with an IHTS equipped with an ESS (IHTS + ESS).

**Direct Coupling Design with small ESS (DCD).** In the preliminary down-selection of PCD Phase, the DEMO plant configuration with Direct Coupling Design BoP (WCLL DCD BoP) developed mainly by the Industry has been considered as the most promising variant to be further developed in CD Phase for feasibility demonstration (see Section 4).

This variant, whose architecture has been studied with detailed transient analysis and stress assessment highlighting the effectiveness of the solution, is based on the direct cycle, in which the Breeding Zone

(BZ) and First Wall (FW) PHTS Once Through Steam Generators (OTSGs) are (directly) thermally connected to the PCS [6]. The heat from divertor PHTS and VV PHTS is used to preheat the PCS feedwater to increase the cycle efficiency. Moreover, the system foresees the adoption of a small ESS operated with HITEC Molten Salt (MS) [10] and heated with electrical heaters. It provides the required heat source to feed the steam turbine during the dwell with a low steam load (about 10 % of its nominal (pulse) value) generated in a Molten Salt-water Steam Generator (MSSG), which maintains the synchronism with the electrical grid and to deliver a small electric power (see Section 4.2).

**Direct Coupling Design with auxiliary boiler (DCD AUXB).** This Direct Coupling Design foresees the adoption of an Auxiliary Boiler (WCLL DCD AUXB BoP), which “replaces” the small molten salt auxiliary loop of WCLL DCD BoP. The steam flow rate during dwell is assured by an auxiliary gas-fired boiler of 250 MW of power, sized to provide a low steam load to the steam turbine in dwell [1,8]. The main drawback of this solution is the large power of the auxiliary boiler, which makes this solution unattractive with respect to other variants.

**Indirect Coupling Design (ICD).** This variant foresees the use of an IHTS + ESS operated with HITEC coupled to the First Wall PHTS. Here the BZ PHTS is thermally coupled to the PCS. The power from BZ PHTS and FW IHTS is used to produce steam to feed the steam turbine. Again the cold sources, i.e. divertor and VV, are used as feed-water heaters, in order to improve efficiency. The energy accumulated in ESS ensures the same steam load to the turbine in dwell as in pulse. The main advantage of this configuration is that a large part of the plant works in steady conditions so that the impact of the transition pulse-dwell is basically on BZ OTSG and other PHTS HXs integrated in PCS. Easier control and operation instead is expected in case of the single phase FW intermediate heat exchanger (water/HITEC). This, however, must be confirmed. Finally, consolidated technology coming from the experience of solar power plants is available for the IHTS design. On the other hand, the very large dimension of the ESS (around 11,000 m<sup>3</sup> each tank) represents a significant disadvantage.

**Additional variants.** As reported in [1,8], a very preliminary industry study was undertaken during PCD phase to minimize the volume of the ESS while ensuring a safe operation of the steam turbine in dwell at very low steam load. The PCS arrangement and the size of the residual energy storage depends on the management strategy of High and Low Pressure Steam Turbines (STs) in dwell (i.e. aligned or disconnected). An

**Table 1.**  
Design and architecture data of DEMO BoP in comparison to fission plant.

	WCLL BoP	HCPB BoP	Fission EPR
<b>Plant thermal Power (MWth)</b>	2260.4 (*)	2366.2 (*)	4300.0
	<b>BoP main systems/equipment</b>		
<b># of separated primary coolant systems</b>	8	14	1
BB	2 (4 loops)	8	-
DIV	4	4	-
VV	2	2	-
RCS	-	-	1 (4 loops)
<b># of primary HX/SGs</b>	10	14	4
BB	4	8	-
DIV	4	4	-
VV	2	2	-
RCS	-	-	4
<b># of pressurisers</b>	8	6	1
IHTS	-	1	-
IHTS MSSG	-	16	-
Small ESS circuit	1	-	-
Small ESS circuit MSSG	4	-	-
Small ESS circuit Electrical Heater	1	-	-
MS tanks	2	2	-
<b>PCS steam cycle</b>	<b>Superheated rankine cycle (Babcock &amp; Wilcox PWR like)</b>	<b>Dual superheated rankine cycle</b>	<b>Saturated rankine cycle</b>
<b>Overall piping length (km)</b>			
PHTSs	13.60	12.81	0.10
BB	6.90	6.28	-
DIV	5.40	5.33	-
VV	1.30	1.20	-
RCS	-	-	0.10
Small ESS circuit	0.0685	-	-
IHTS	-	1.52	-
<b>Coolant inventories (m<sup>3</sup>)</b>			
PHTSs	1577	2578	460
BB	722	1735	-
DIV	270	244	-
VV	585	599	-
RCS	-	-	460
Small ESS + tanks	55+1500	-	-
IHTS + tanks	-	1000+2600	-
(*) Total Power of BB+DIV+VV;			
<b>Acronyms</b> - Small ESS: Small Energy Storage System; MSSG: Molten Salt Steam Generator.			

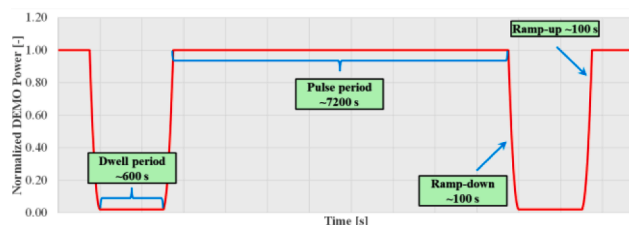

**Fig. 3.** Demo power profile with pulse and dwell time periods.

innovative connection of the High Pressure (HP) section to the Low Pressure (LP) [12] through high power clutches is foreseen. The LP ST is “detached” from HP LP in dwell and decelerates. This configuration, will be further investigated in the future through a robust R&D aiming at demonstrating a suitable LP ST blade design to comply with the

challenges of the very low load operation.

An additional BoP ICD option has been introduced as possible back-up to the Direct BoPs. The idea relies in the adoption of a Small ESS to operate the steam turbine at low load during the dwell, but connected to an intermediate loop placed in between BB PHTS and PCS. This solution could minimize potential regulation and stability issues especially related to the OTSG.

### 3.1.2. HCPB BoP variants

Four main variants have been considered: three DCD options and one Indirect Coupling Design (HCPB ICD BoP) concept, which is the reference HCPB DEMO BoP layout [9,45].

**Indirect Coupling Design (ICD).** This variant uses an IHTS equipped with an ESS operating with HITEC MS [10] to decouple the whole BB PHTS from the PCS. The IHTS design uses qualified technology coming from Concentrated Solar Power (CSP) plants [18]. The work has been supported by industry and focused on investigating different PHTS and PCS (i.e. feedwater train optimization for pulse and dwell conditions) architectures. This has led to a quite robust design that contributed to the selection of this BoP as the reference configuration for HCPB (see Section 5).

**Direct Coupling Design: auxiliary boiler (DCD-I).** Similarly to the WCLL BoP DCD AUXB, a gas-fired boiler has been considered to provide high pressure/high temperature steam flow to keep the power train in operation in dwell [11]. The size of the boiler depends on the selected steam mass flow rate for steam turbine safe operation in dwell. In this case, if the steam turbine would be driven at about 10 % of pulse steam load in dwell, a small gas-fired power station of around 200 MW<sub>th</sub> is needed. The assessment of costs, requested size and heat transfer constraints makes this option unattractive.

**Direct Coupling Design: DCD-s1 small boiler plus solid state ESS.** The second DCD variant collects fusion energy during pulse and stores it in a Solid State (SS) ESS. The collected thermal energy is then released to the PCS during the dwell period. This reduces boiler size so that this variant becomes more reasonable. Nevertheless, the ESS is not able to release the thermal energy within the relatively short dwell time, being realized in HT-concrete. Furthermore, the piping and control system becomes very complicated and, most importantly, the solid ESS works as a HX; heat is stored from PHTS-Helium on one side and PCS-water/steam removes the heat during dwell on the other side. Since the PHTS safety function could not be maintained due to spatial request of the ESS, further investigations have been postponed to the CD Phase as a back-up solution.

**Direct Coupling Design: DCD-s2 small ESS plus electrical heater.** The third DCD variant has an architecture similar to WCLL BOP DCD. It uses HITEC (400 m<sup>3</sup>) and a 41 MW<sub>e</sub> electrical heater. This is done in order to maximize electrical power production of the PCS during pulse and maintain synchronization between the electrical generator and grid during dwell period while operating the steam turbine at a minimum operational load of 10 %. According to preliminary assessments, this variant has shown the fewest integration and feasibility risks, providing that proper control strategies and suitable design solutions are adopted to minimizing the impact of thermal-hydraulic transients on main equipment. Nevertheless, further studies, focused on creep assessment, and start-up evaluations are needed to confirm this solution as first back-up choice in case the ICD option would present some design integration challenges.

## 4. The design status of WCLL DCD and feasibility assessment

As already mentioned in Section 2, the reference variant WCLL DCD

BoP (see Fig. 1) basically consists of the PHTSs, the small ESS and the PCS. The PHTSs ensure the heat removal from the BB, the divertor and the VV. More specifically, the BB PHTS delivers power to the steam generators, foreseen for the steam production at suitable conditions for the turbine feeding, while heat removed by the divertor and VV PHTSs is used to preheat PCS feedwater by means of their HXs integrated in the Feedwater Heaters (FWH) train. This ensures an effective use of the heat sources to ensure maximization of the overall plant efficiency. Furthermore, the small ESS is foreseen to guarantee a reduced steam production in dwell (around 10% of the pulse value) to keep operating (i) the PCS in order to limit thermo-mechanical stresses in its components and (ii) the electric generator synchronized to the grid according to system requirements.

It is noting that the preliminary cost assessment of the WCLL DCD BoP provided a value significantly lower than in case of WCLL ICD BoP, even if attention should be paid for potential development work on the ST necessary to cope with the challenges of the pulsed operation, [8].

#### 4.1. The WCLL PHTSs design description

##### 4.1.1. BB PHTS

The main function of the BB PHTS is to remove the heat produced in the BB components, delivering thermal power to the PCS by means of four OTSGs. Currently, the BB PHTS is divided into two independent cooling systems, foreseen for the heat removal from the BZ and FW. Both the BZ and the FW PHTSs consist of two cooling loops based on existing technologies derived from Pressurized Water Reactor (PWR). Each BZ primary loop comprises an OTSG, two Main Coolant Pumps (MCPs), and their connections. In addition, a shared pressurizer is installed in one of the two BZ PHTS loops. A similar configuration is adopted for the FW PHTS, except for the pumping system that accounts for a single MCP per loop.

The BZ PHTS cold legs, as well as the FW PHTS cold legs, feed their respective cold rings, which accomplish the distribution of the cold water to each in-VV BB sectors through their branches. Primary coolant removes power from the BZ/FW and is collected in the hot rings that deliver water to the hot legs. In case of pump trip in a single BZ/FWZ PHTS loop, the other cooling loop guarantees the power removal from the whole system after the shutdown.

##### 4.1.2. Divertor PHTS

The divertor PHTS has the main function of removing power deposited in the divertor System, currently consisting of two cooling systems: one for the PFC and the other one for the Cassettes supporting structure. Both the divertor PFC and divertor cassette PHTSs consist of two 50% independent loops that remove power from eight out of sixteen sectors. Each cooling loop consists of an HX, a pressurizer, a pump, a system of collectors and distributors, and their connections. During pulse operation, divertor PFC PHTS and divertor cassette PHTS remove 136 MW and 115.2 MW respectively, delivering power to the PCS FWH train. The reference operative pressure is respectively 5.0 and 3.5 MPa while the reference inlet/outlet temperatures are 130/136 °C for divertor PFC PHTS and 180/210 °C for divertor cassette PHTS. The inlet and outlet temperature of the divertor system are still being debated and could change in the future. Under dwell operation, the systems work at around 1% of the nominal power and, on the PCS side, most of the feedwater flow rate is bypassed.

##### 4.1.3. VV PHTS

The primary function of the VV PHTS is to remove the power deposited in the Vacuum Vessel. The VV PHTS consists of two independent cooling loops, each one in charge 50% of the total power. Every cooling loop consists of an HX, a pressurizer, a pump, a system of collectors and distributors, and their connections. The two loops are conceived to feed alternatively the even and odd sectors. The nominal power removed by the VV PHTS is 86 MW and the thermodynamic cycle

is currently based on pressurized water at 3.1 MPa and tentative inlet/outlet temperatures of 190/200 °C. The temperature of the vacuum vessel coolant is still being debated and could change in the future. During the dwell period, the VV PHTS removes around 1% of the nominal power and, on the PCS side, most of the feedwater is bypassed. In addition, the VV PHTS has a further safety task. In case of complete and prolonged loss of cooling of the whole in-VV components, this system must guarantee the Decay Heat Removal (DHR) function. For this purpose, each cooling loop belonging to the VV PHTS foresees an emergency DHR HX and a DHR pump. The emergency system must avoid temperature increases that would compromise structural integrity. The DHR HXs are designed with a nominal power of 3 MW and the reference inlet/outlet temperatures are 190/200 °C. The secondary side is fed with the Chilled Water System (CHWS).

Table 2, taken from [1], summarizes the main design parameters of WCLL PHTSs.

##### 4.1.4. BB OTSG design and preliminary verification

A preliminary mechanical sizing and thermo-mechanical verification has been addressed on the WCLL BB PHTS OTSGs on the basis of the thermo-hydraulic and geometrical data of Table 3. The design of the OTSGs along with the stress analysis and lifetime prediction of their relevant parts have been performed to evaluate the feasibility of these components under the DEMO requirements. The reference design of the OTSG [12,13] is a vertically oriented, once-through, up-boiling, cross-counter-flow, shell and tube heat exchanger. The design is inspired to the Babcock&Wilcox (B&W) PWR technology [14–16]. The bundle can be divided into two sections: a boiler that converts water into steam and a super-heater section (Fig. 4). The hot primary coolant enters from the top, flows downward inside Inconel tubes, and exits from the bottom. Feedwater is introduced at the midplane through several inlet nozzles around the shell and flows downward in an annular chamber between the shell and the tube bundle shroud. Feedwater is preheated to saturation by steam before entering the bundle, which is drawn from the high-quality steam region of the tube bundle just above the feed-water nozzles. The flow of steam through the space between the upper and lower portions of the shroud is created by the condensing action of the steam as it comes into contact with feed-water spray. Saturated feed-water enters the tube bundle at the bottom and begins to boil immediately. The steam is boiled to dryness at approximately two-thirds of the bundle's height and is then superheated to ensure dry steam is delivered to the turbine. Steam from the bundle is diverted downward through the upper annulus and leaves the generator through two steam outlet nozzles.

The layout of the OTSGs for the preliminary mechanical design and CAD implementation considers service level A loads due to internal

**Table 2.**  
WCLL PHTSs main design parameters [1].

Parameters	Value
BB PHTS (FW + BZ)	
Power [MW]	1923.2
PHTS piping size hot/cold leg range	DN500-850
PHTS piping overall length [m]	3200 + 3700
PHTS Pumping power [MW]	16.52
PHTSs overall coolant volume [m <sup>3</sup> ]	563 + 159
Divertor PHTS (PFC + Cassette)	
Power [MW]	136 + 115.2
PHTS piping size hot/cold leg range	DN300-600
PHTS piping overall length [m]	2600 + 2800
PHTS Pumping power [MW]	12.0 + 1.6
PHTSs overall coolant volume [m <sup>3</sup> ]	128 + 142
VV PHTS	
Power [MW]	86
PHTS piping size hot/cold leg range	DN350
PHTS piping overall length [m]	1300
PHTS Pumping power [MW]	3.1
PHTSs overall coolant volume [m <sup>3</sup> ]	585

**Table 3.**  
WCLL-OTSG Thermo-hydraulic and geometric data.

Parameter	Unit	Value
SG Power	MW <sub>th</sub>	742
Primary side pressure	MPa	15.5
Primary side water T <sub>in</sub>	°C	328
Primary side water T <sub>out</sub>	°C	295
Secondary side pressure	MPa	6.41
Secondary side water T <sub>in</sub>	°C	238
Secondary side water T <sub>out</sub>	°C	299
No. of tubes	–	7569
Tube OD	mm	15.88
Tube Thickness	mm	0.864
Tube Length	m	12.987
Tube-sheet Lattice	–	Square
Tube-sheet p/D	–	1.28
Heat transfer area	m <sup>2</sup>	4903
V water tubes	m <sup>3</sup>	20
D <sub>ext</sub> vessel	m	2.9

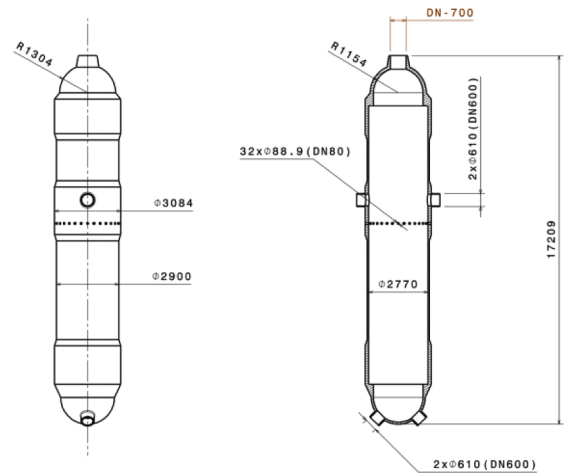

**Fig. 5.** OTSG general arrangement with inlet/outlet interfaces [13].

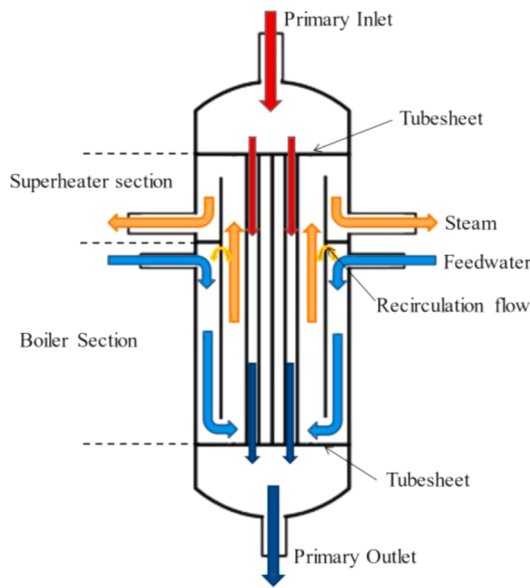

**Fig. 4.** Conceptual scheme for Once through steam generator.

pressure, thermal load, and weight effects (both dead weight and live weight) [12] as well as main cyclic loadings as thermal expansion & contraction and pressure fluctuation due to normal operations and the pulse/dwell transitions.

Inconel alloy 690 (UNS N06690, W. Nr. 2.4642 and ISO NW6690) was selected as the reference material for the tubes, due to its excellent resistance to stress corrosion cracking and intergranular attack. Low-alloy SA-533 Gr. B class 1 (Mn-½Mo-¾Ni) was assumed as structural material for the remaining components. The OTSG design is reported in Fig. 5 and Table 4.

The thermo-mechanical analysis of the OTSG [17] has been performed to verify the design, estimating the stress of the different parts and the life-time, taking into account also of fatigue effects. It has been developed considering conservative hypotheses regarding the water level variation from pulse to dwell conditions, the heat transfer coefficients and temperature differences in relevant part of the component as well as adopting conservative methodologies. It is expected that this approach can compensate the simplification assumed to not consider any loads deriving from potential oscillations of the interface steam-liquid inside the OTSG during the transition pulse-dwell.

Analyses and sensitivities have been carried out using design standards instead of FEM. Taking into account the different OTSG parts as well as their manufacturing method adopted, the following applicable

**Table 4.**  
WCLL-OTSG main geometric data.

Parameter	Unit	Value
Tube OD	mm	15.88
Tube Thickness	mm	0.864
Tube Length	m	13
Tube-sheet Lattice	–	Square
Tube-sheet p/D	–	1.28
Shell basic thickness	mm	65
Shell maximum thickness	mm	157
Hemispherical heads thickness	mm	150
Tube-sheet thickness	mm	610
Support plate thickness	mm	32
Shroud thickness	mm	25
D <sub>ext</sub> vessel	m	2.9

codes have been considered: EN 12952-3 [18] and ASME Section III Division 1 NB – 3338.2 [19] for the OTSG nozzles; ASME Section III Division 1 – Subsection NB-3214 [19] and the ASME Section III Division 1 - APPENDIX A-8000 [20] for the tube-sheets and ASME Section III Division 1 – Subsection NB-3653.2 [19] for the tubes. For the fatigue calculation, two different codes were used: ASME Section III [19] and EN 13445 [21]. The lifetime prediction was calculated for both unwelded and welded joints (Fig. 6).

In general, the results showed that the lifetime of all the OTSG parts investigated (for both welded and unwelded postulated joints) is well

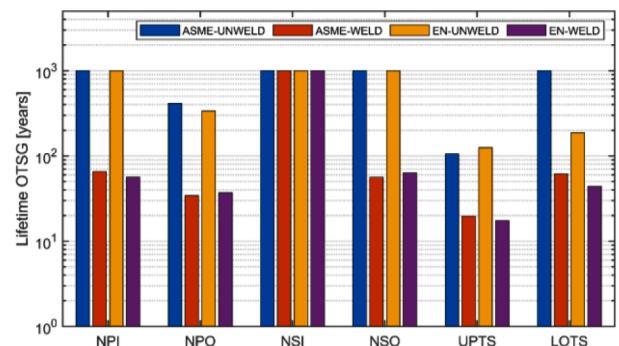

**Fig. 6.** Lifetime analysis results in the OTSG. (NPO= Nozzle of Primary coolant Outlet, NPI=Nozzle of Primary coolant Inlet, NSO=Nozzle of Secondary coolant Outlet, NSI=Nozzle of Secondary coolant Inlet); UPTS= UPper Tube-Sheet; LOTS= Lower Tube-Sheet. EN: standard elaborated by the Comité Européen de Normalization; ASME: standard elaborated by the American Society of Mechanical Engineers.

above 20 Full Power Years (FPY), with exception of the OTSG tube-sheets, using the more restrictive EN-13445 which showed a lower lifetime value.

Considering the operational life of DEMO (around 2-5 FPY for first and second blanket - Ref. [36]), these results show that the proposed design can be considered largely verified with large margins. It is also highlighted that load fluctuations in OTSGs typically produce higher amounts of corrosion products compared with normal base-load operation [26]. This also includes the accumulation of radionuclides which could increase the radiation field for the operators, [44]. For these reasons, a proper inspection and cleaning plan must be foreseen to avoid the accumulation of corrosion products and dust deposits, as well as of activated corrosion products.

#### 4.2. PCS design and preliminary stress analysis

##### 4.2.1. "Pulsed" PCS architecture

The PCS of the WCLL BoP DCD has been developed with the support of Industry. The main requirements were to maximize electrical power production during pulse and maintain synchrony between the electric generator and grid during dwell period. Suitable provisions and specific design choices were identified and implemented in order to limit the adverse impact of the pulsed operation, [27].

The developed system relies on a Rankine type power block composed of conventional components and solutions with the following peculiar provisions: (i) the introduction of a suitable storage for energy accumulation in order to keep running the ST during dwell and the main PCS components warm and ready for the next ramp-up. As said, the MS circuit with its storage system (i.e. the Small Energy Storage System)

interfaces the PCS through the MSSG which generates a suitable steam load for PCS dwell operation; (ii) the introduction of a suitable bypass system in order to control primary water temperature of the cold sources; (iii) the identification of suitable ST power load in dwell and ST loading and unloading rate in the transition phases of pulse-dwell and dwell-pulse.

For the layout identified (see Fig. 7), steady state thermodynamic heat balance in "pulse" and "dwell" have been assessed; main control loops for PCS have also been defined and preliminary sizing of the heat exchangers, piping, pump and ESS performed. The identification of a reference applicable steam turbine design with evaluation of the machine performance in pulse and dwell has also been performed. PCS main features are summarized in Table 5.

##### 4.2.2. PCS regulation outcomes

With the aim to evaluate the system behavior and the thermo-mechanical stress, a first transient analysis was performed thanks to a PCS MATLAB-Simulink model, including all regulation scheme details

**Table 5.**  
WCLL DCD BoP PCS main parameters.

Parameter	Value
Small ESS power Electric Power [MW]	41.2
Small ESS hot/cold tank number	1/1
Gross Output (pulse/dwell) [MW]	791.6/62.9
Cycle efficiency (pulse/dwell)	33.9%/19.4%
Overall efficiency	31.0 %
Steam turbine type (HP+2LP)	1500 rpm

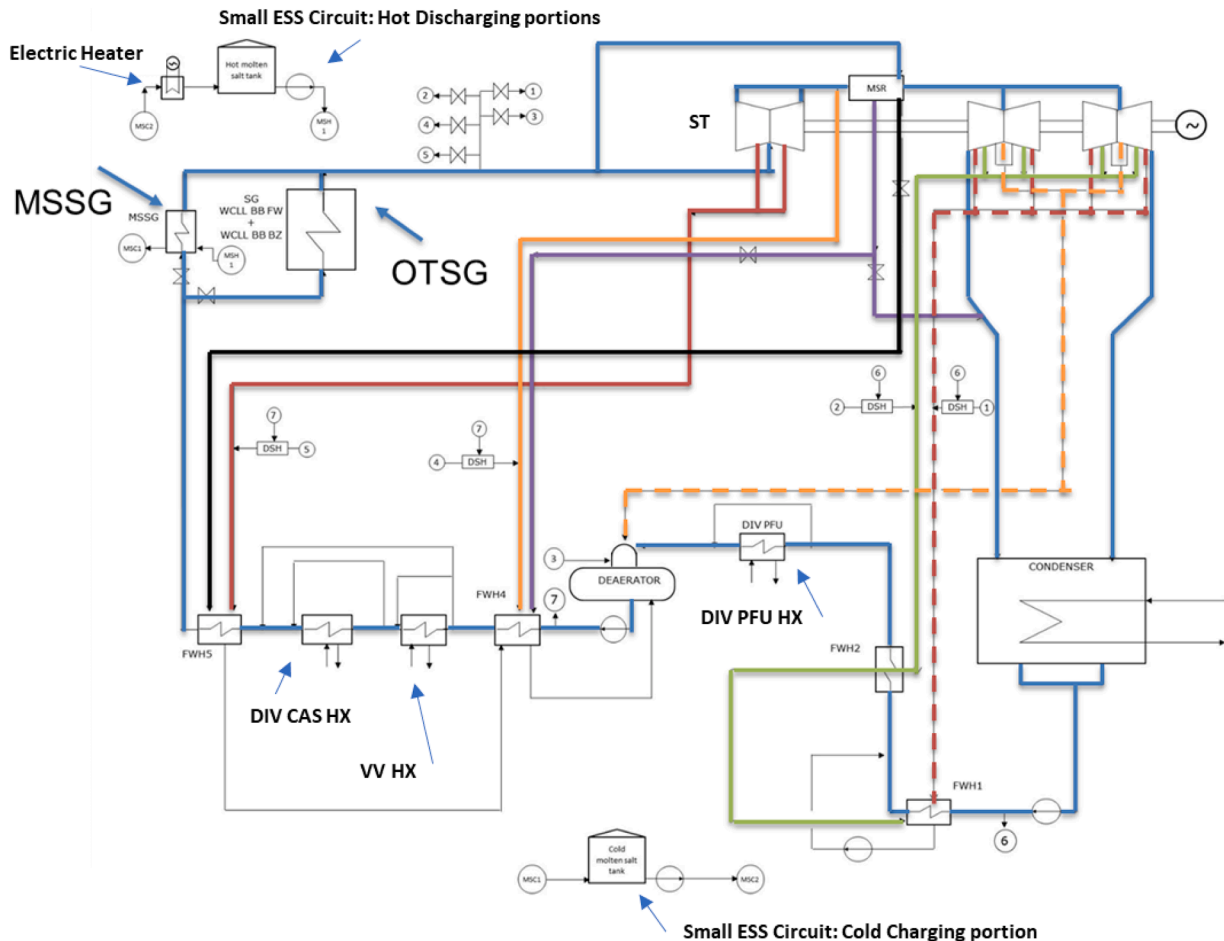

Fig. 7.. WCLL BoP reference configuration: PCS architecture with small ESS.

(~x223C40 control loops implemented) and related control parameters.

The developed regulation proved effective in sustaining the complete pulse-dwell-pulse transition and to bring variables in their original (pulse) steady state value after the transient; this occurred also assuming the most realistic and challenging plasma power curve (see the red curve where in 2 s the plasma power rises from 15% to more than 80% -Fig. 8).

The regulation scheme is characterized by an indirect control of the PHTS coolant average temperature along the DEMO period; namely it implements a control of the power exchanged on each primary SG/HX performed through the regulation of the feedwater flow; the latter is upper bounded so that to prevent any ST flooding Through this it has been possible to achieve: (i) a very good steady state pulse hot, cold and average temperature value, (ii) a good quasi-steady state temperature during the dwell and (iii) a primary coolant average temperature in dwell very close to the requirements (see an example in Figs. 9 and 10), without harming the ST with water and limiting the thermal stress on the primary side heat exchangers.

#### 4.2.3. PCS stress assessment

For all the HXs/SGs in the model, due to the very small thickness (thk) of the tube, the temperature distribution in its metal walls can be assumed as linear and evolving through quasi steady state steps. In such cases, the simplification in the representation of the tube thickness as a single node at the wall average temperature ( $T_{avg}$ ) is acceptable. Moreover,  $T_{avg}$  corresponds to the temperature value in the middle of the tube thickness ( $T_{mid\_thk}$ ).

Dynamic simulations have been performed which provided the time evolution of the: (i)  $T_{mid\_thk}$ , of the (ii) bulk temperature of the hot and cold fluids flowing inside and outside the tubes as well as of the (iii) internal/external tube wall surface convective Heat Transfer Coefficient (HTC) in different position of the HX tubes including the inlet, outlet and the most stressed point (i.e. at the tube-reinforcement baffle connection). In this case, appropriate stress concentration factors according to standards were used.

Thermal stress in both internal and external wall surfaces ( $\sigma_{int\_wall\_surface}$  and  $\sigma_{ext\_wall\_surface}$  respectively) have been obtained by applying the cylinder thermal stress formula below:

$$\sigma_{int\_wall\_surface} = \frac{E\alpha}{(1-\nu)} * \frac{HTC_{int\_wall\_surface}}{HTC_{int\_wall\_surface}+2k/thk} * ($$

$$\sigma_{ext\_wall\_surface} = \frac{E\alpha}{(1-\nu)} * \frac{HTC_{ext\_surface}}{HTC_{ext\_surface}+2k/thk} * ($$

Very low thermal stress has been predicted for all the SG/HXs in PCS both in pulse and in dwell. In particular, in dwell, the low cold fluid (feedwater) HTC yields a near zero stress due to the relatively uniform

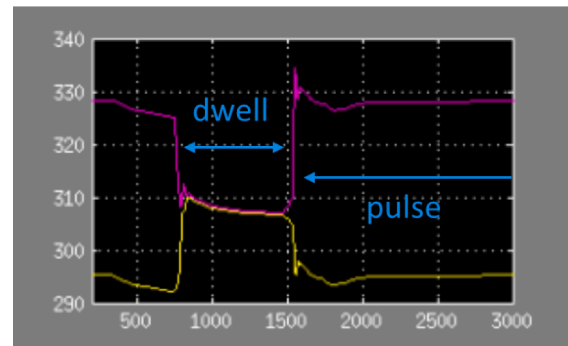

Fig. 9.. BB PHTS coolant temperature time profile: at BB inlet (yellow) and outlet (magenta), (°C).

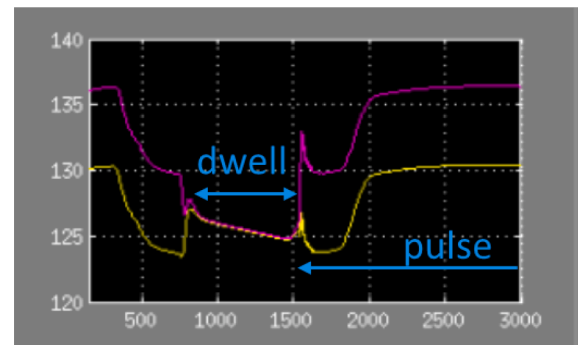

Fig. 10.. Divertor PFC PHTS coolant temperature time profile: at divertor PFC inlet (yellow) and outlet (magenta), (°C).

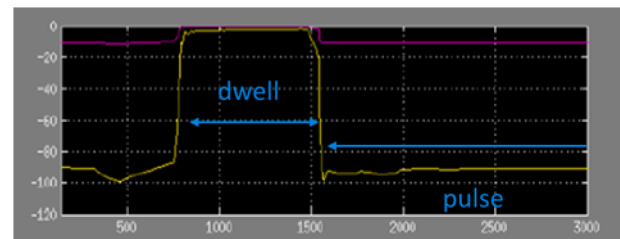

Fig. 11.. OTSG: Thermal stress @most stressed point; values for the tube internal/external wall surface (yellow/magenta respectively), MPa.

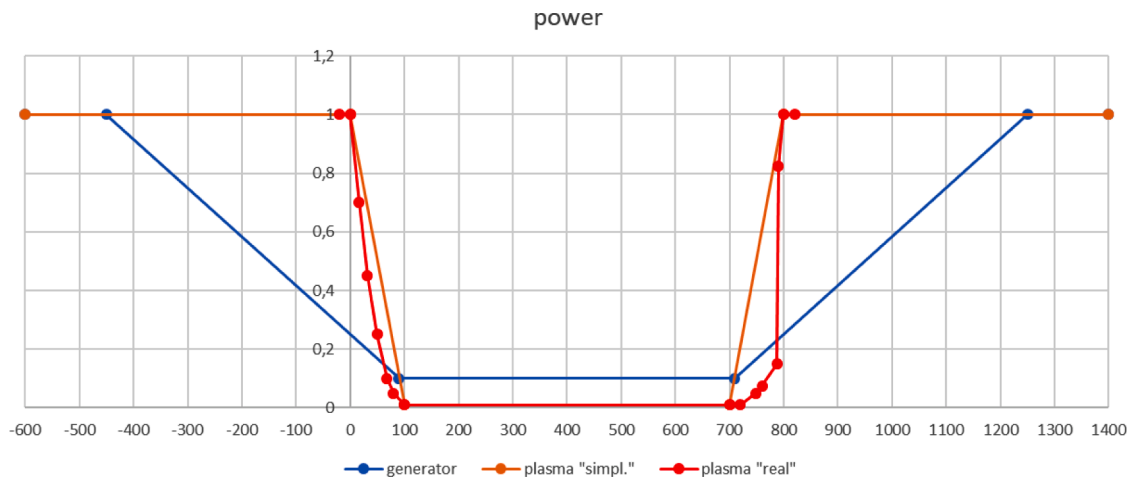

Fig. 8.. Fusion power ramps: actual (red), simplified (orange) and ST/generator load ramp (blue).



tube metal temperature, see Fig. 11 reporting OTSG stresses as an example.

Mechanical stress has been calculated with a similar procedure. The simulation showed that for every HXs/SGs the resulting stress is low and compatible with the required operation cycle (virtually infinite fatigue cycles allowed).

Moreover, a dedicated transient FEM analysis was carried out on the ST.

In fact, the pulse-dwell transition could be a challenging aspect for the steam turbine due to the potential changes of the rotor temperature because of different operating pulse-dwell thermodynamic points. Nevertheless, (i) the assumed ST operative power profile and steam unloading and loading rate (i.e. ST steam load changes according to 100%-10%-100% profile and power transition pulse-dwell and dwell-pulse in 100 s); (ii) the constant inlet steam enthalpy/steam temperature to the HP/LP section and (iii) the low HTC in dwell (which isolates the rotor from the colder steam) determined moderate stress allowing the rotor to perform at least 200,000 pulse-dwell-pulse cycles - well above those expected during DEMO life - with no fatigue damage.

This outcome has been obtained thanks to a Low Cycle Fatigue (LCF) transient analysis on both the HP and LP steam turbine rotor and a detailed FEM analysis to verify the most stressed location [28]. The maximum value of stress is reached during transient in the first blade groove, while for the LP ST the maximum stress is located downstream of the second weld on both rotor sides. Fig. 12 and Fig. 13 show the HP rotor results obtained using the FEM model and the HP rotor most stressed location respectively.

#### 4.3. Feasibility and reliability assessment of the WCLL DCD and open issues

##### 4.3.1. Design, manufacturing and functional feasibility

The BoP architecture related to the DEMO WCLL BB was developed considering existing and proven technologies to minimize feasibility risks.

The OTSG has design data and size comparable with similar components used in PWR. The same applies for the Decay Heat Removal HX tube-sheet that shall withstand high temperature gradients, but size and pressure difference are small.

The PHTS loop pressurizers are comparable or smaller than PWR pressurizers; the primary pumps have smaller power than typical PWR pumps, except for the ones of divertor PFC loops and would possibly have a slender impeller, but it is not expected to cause any significant manufacturing challenges.

Concerning the piping, the Tokamak and SGs hot/cold legs will be affected by thermal stress and fatigue, as they experience the highest

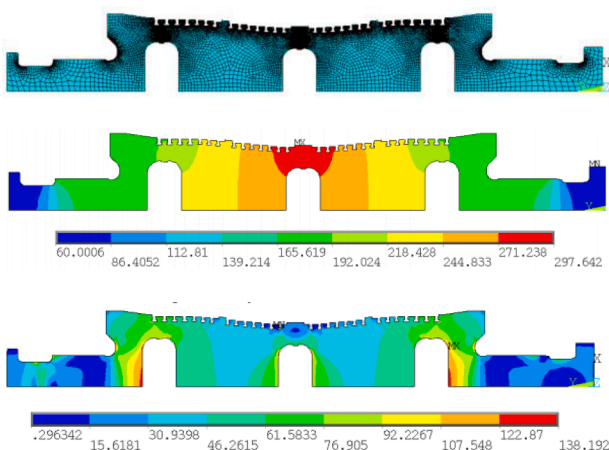

Fig. 12.. BoP HP rotor preliminary – FEM Model, steady state HP rotor temperature field, and steady state stress intensity (from top to down of Fig. 12).



Fig. 13.. HP Blade 1 groove, max Von Mises stress.

pressure and temperature variations. This will be further investigated, but solutions to mitigate possible issues have been already identified.

Moreover, it is important to observe that the PCS proven components, as stated also in [8], that can successfully withstand (ST rotor included) all thermo-mechanical loads caused by the pulse-dwell normal operation.

In conclusion, the WCLL plant option proved to be feasible and problem-free on the stress side.

Nevertheless, the pulsating nature of the plasma generated thermal power poses unique challenges to the functional feasibility of the OTSG both in terms of stability of the operation and adequacy of performance in dwell (low load) and in the transition pulse-dwell. The same applies also to the steam turbine where an open issue is represented by the very large off-design conditions of the steam turbine in dwell (10% steam load in Small ESS “pulsed” PCS or even smaller in “No Storage” option). In fact it could represent a risk, due to the potential for adverse effects of ventilation phenomena occurring in the LP ST last stage blade (i.e. vibrations, high temperature, and high thermo-mechanical stress). This is the reason for the planned R&D, which aims at verifying/developing a suitable blade design for DEMO use.

These aspects are crucial for the BoP feasibility demonstration and will be addressed in FP9 (Section 6.1).

##### 4.3.2. Plant regulation

It has to be stressed that DEMO operation poses unique challenges for the control system design; for example, comparing the ramps of fission power plants (about 5%/minute) to that of DEMO (a plasma power step of +65% occurs in 2 s). Therefore, despite a comprehensive and detailed regulation scheme, the (usual) direct control of the primary coolant temperature, i.e. the tracking of a given temperature setpoint in a reasonable time, was not fully successful, due to: (i) little design margin for saturation of the steam exiting the OTSG, causing the additional tight requirements to not exceed more than 6% of the -very small- dwell design mass flow rate (10.1 kg/s) and more than 3% of the design pulse mass flow rate in order to avoid steam turbine flooding, (ii) very fast plasma dynamics, requiring a fast response of the control system to prevent primary side overheating during ramp up, incompatible with the heat exchanger secondary side thermal inertia and low HTC in dwell; (iii) the requirement of primary coolants mass flowrate in dwell at nominal pulse value to be controlled by a tiny feedwater flow of a couple of order of magnitude smaller.

This led to the development of the indirect coolant temperature control mentioned in Section 4.2. However, should the obtained performance be judged insufficient by the designers, an improvement of the control system should be done. The latter should (i) eliminate the present conservatism adopted (i.e. no primary system thermal inertia accounted, in-VV heat sources included) that increases the impact of the steep plasma power ramps and mainly (ii) base on a predictive architecture, developed from the knowledge of the plasma and the OTSG

dynamic behavior, so that to generate anticipating control signals to ensure stability of the operation and the control of the T/H parameters in the plants to their setpoints.

Another open issue of the “pulsed” PCS refers to the interfacing electric generator coupled to the steam turbine; a suitable design should demonstrate its viability in handling the trapezoidal profile of the turbine mechanical power once connected to the electrical grid.

#### 4.3.3. Reliability

For the achievement of DEMO goals, another fundamental BoP feature is to have adequate availability.

During the PCD Phase, the Reliability, Availability, Maintainability and Inspectability (RAMI) study has been started with the aim of identifying the most critical components on which focus the design improvement.

A preliminary RAMI analysis of the DEMO WCLL Direct and Indirect BoP has been carried out and reported in [42,1]. The study starts with the identification of all the events that could affect the RA of the system, through a Failure Mode and Effect Analysis (FMEA); then a quantification of their RA parameters is performed through a Reliability Block Diagram (RBD) analysis approach, considering the maintenance and inspection operations performed on components and equipment during their plant life.

Suitable assumptions have been considered where WCLL BoP design data was unavailable, based on the experience of the analysts and in similar applications from nuclear power plants and ITER design.

Four unavailability scenarios have been considered in the analysis: the Chemical and Volume Control System – CVCS (a process auxiliary of the PHTSs) unavailability with PHTSs and reactor still in operation, PCS unavailability for a short time without request of reactor shutdown, ESS unavailability for short time without request of reactor shutdown, and complete unavailability of the reactor (its operations are impaired by the failure itself or by the induced failures of other components of equipment). Furthermore, the likelihood of single component failures has been mainly estimated from the Fusion Component Failure Rate Data Base (FCFRDB) [24,25], that collects data useful for probabilistic assessment in nuclear fusion and fission field [12,14,15].

The FMEA, allowing assessment of the frequency of occurrence of failure events, highlighted that an out of service of the DEMO reactor for weeks or months, due to undetected and unmitigated initiating events in the WCLL BoP (because of the aggravating failure of control systems), is not expected during the life of the plant. In the case of detected and mitigated initiating events, *up to 10 events* can occur every year, requiring the stop of the plant. Furthermore, several events could induce a sub-system shut down, such as CVCS, every year.

Moreover, the RBD analysis, where each item involved in the plant operation is represented with an individual block characterized by specific reliability maintenance and interoperation features, highlighted that the reliability to operate the WCLL DCD BoP for one full year without fault is 3.42%. Such a low value is mostly affected by the wide number of valves postulated in the CVCSs and in the overall BoP as well as by ST.

In any case, even from RBD analyses, where repair and restoration actions can be simulated, the predicted WCLL DCD BOP yearly operation and inherent availability is 52.57% - 87.1% in the first three years respectively, decreasing to 39.31% - 80.77% in the twentieth year of operation. Therefore, considering the preliminary target requirements were set of 30% and 48%, both the three and twenty years data are compliant. Finally it is expected that these WCLL BoP performance should improve in the light of the actual DEMO operational concept envisaging around 2/5 FPY of first/second blanket operation [36].

## 5. The design status of HCPB ICD and feasibility assessment

The reference DEMO HCPB BoP concept (see Fig. 2) uses an IHTS and ESS operating with HITEC MS to decouple regular plasma pulses from

the PCS [1]. As already mentioned, the IHTS design is based on industrially qualified technology coming from CSP plants ( $\sim 223\text{C}200\text{ MW}_e$  and energy storage up to  $1\text{ GWh}_{th}$ ).

The first HCPB BoP ICD design was conceived in 2013 and it has been improved since then thanks to the plant functional assessment performed using the EBSILON software, [38], supported by industry with respect to the power conversion system and Helium circuit. EBSILON results have been confirmed by the code APROS [37] and GateCycle [39] codes calculations. In addition, a dynamic model was developed based on MATLAB/SIMULINK to investigate the dynamics of the transitions pulse-dwell and dwell-pulse [29]. Some highlights of DEMO HCPB BoP ICD are provided here, following their extensive description in [1] and [8].

### 5.1. The HCPB PHTS design description

The Primary task of PHTS is to supply coolants at due conditions to the BB (using helium as coolant), the Divertor and the Vacuum Vessel (using water). For the BB PHTS the heat sink is the HITEC of IHTS, while the energy of the divertor PHTS and the VV PHTS is transferred via heat exchangers to the feedwater train of the PCS to enhance overall system efficiency. Highlights of DEMO HCPB PHTS are provided here with an extensive description in [1,8].

#### 5.1.1. BB PHTS

The BB PHTS is segmented into 8 loops (see Fig. 2) [1], each providing Helium coolant to 2 sectors (in total 6 outboard plus 4 inboard BB segments) via upper ports [30,31]. Among all possible BB PHTS segmentations, this offers the largest benefits with respect to safety [34], component sizing and maintenance, as the actual PHTS concept does not foresee any valves in the cooling loop.

The helium velocity in the main coolant line is kept limited, thus leading to feasible pipe diameters ( $< 1.3\text{ m}$ ). For safety reasons, each loop incorporates two helium circulators in parallel so that one blower alone could provide sufficient cooling to the BB while correctly ramping down the plasma without unintended breakdown. The design limit is the size of the component and, because of the narrow market, component costs are high. A remaining open issue is the performance in low power operation during dwell time, which could be solved by a circulator bypass. A similar concept was pursued in a preliminary industry proposal where, differing from the designer choices, the two components were arranged in series. As related to the He-MS main Intermediate Heat exchanger (IHx), two possible solutions have been proposed: a once-through straight tube HX (reference) [32] and helical-tube HX (alternative). Further analyses should be done to assess advantages and drawbacks for final selection.

#### 5.1.2. Divertor cassette/PFC PHTS and VV PHTS

Currently, it is assumed that the divertor and VV PHTSs of the WCLL and the HCPB BB concepts adopt the same layout, input power, coolant inlet/outlet temperatures, flow-rates, and etcetera. This can be observed by comparison in Tables 2 and 6 that summarize the main design parameters of HCPB PHTSs. However, small changes in the design of the heat exchangers can occur, according to the different conditions of the interfacing PCS feedwater.

In the case of WCLL, large PCS feedwater bypass around HCPB divertor/VV PHTS HX is arranged to comply with the very low decay power in dwell.

#### 5.1.3. An insight on the divertor HXs mechanical design and preliminary verification

The divertor HXs reference design is a plate-baffled shell and tube exchanger. In the assessment developed in [35], a nominal tube diameter of 25.4/ 15.875 mm with a wall thickness of 1.245/1.651 mm has been selected for the divertor PFC and cassette HX respectively. Table 6 shows HCPB PHTSs main design parameters.

**Table 6.**  
HCPB PHTSs main design parameters, [1].

Parameter	Value
<b>BB PHTS</b>	
Power [MW]	2029
PHTS piping size hot/cold leg range	DN1100-1300
PHTS piping overall length [m]	6282
PHTS pumping power [MW]	92
PHTS overall coolant volume [m <sup>3</sup> ]	1735
<b>Divertor PHTS (PFC + Cassette)</b>	
Power [MW]	136 + 115.2
PHTS piping size hot/cold leg range	DN300-600
PHTS piping overall length [m]	2545 + 2787
PHTS pumping power [MW]	14.5 + 1.6
PHTS overall coolant volume [m <sup>3</sup> ]	114 + 130
<b>VV PHTS</b>	
Power [MW]	86
PHTS piping size hot/cold leg range	DN350
PHTS piping overall length [m]	2475
PHTS pumping power [MW]	2.63
PHTS overall coolant volume [m <sup>3</sup> ]	599

After sensitivity studies, the final tube thicknesses have been selected to avoid the possible occurrence of tube buckling due to different thermal expansion between the tube and the shell material during operations. Regarding the bundle layout, square tube lattices with pitches of 38.1/23.8 mm have been selected for the divertor PFC/cassette HX, respectively. The SA-508 Gr. 3 Class 2 low-alloy steel was adopted for the exchangers' structures, while Inconel alloy 690 was selected as reference material for tubes.

The main divertor HXs design data are reported in Table 7 while the layout is shown in Fig. 14.

As occurred in the case of WCLL BoP OTSG, the mechanical design of these HXs has been verified through a thermo-mechanical analysis, assessing the stress in the most critical parts as well as the lifetime [39]. The main parts of the divertor-PFC HXs and divertor cassette HXs selected for the analyses are the primary coolant inlet and outlet nozzles, the secondary coolant inlet and outlet nozzles, the upper and lower tube-sheets, and the tube bundle. Loads have been derived from the fluids working conditions (pressure and temperature), including the temperature difference between hot and cold fluid (inducing a thermal load) and its variation during the pulse-dwell operation that causes fatigue. Figs. 15 and 16 show the positions of the nozzles and tube-sheets.

As in the case of WCLL OTSG, preliminary verifications have been made using different codes (instead of FEM) namely: European and ASME standards with the aim to achieve a very conservative prediction of stress and lifetime and perform a comparison. The codes used for the identified divertor HXs locations are the same of those already mentioned for the OTSG design; stress in the HX tubes were also assessed according to ASME Section III Division 1 – Subsection NB-3214 [19]. From Figs. 17 and 18, it can be observed that the lifetime prediction in the HX more stressed parts is generally higher in case of divertor PFC HX than in case of divertor cassette HX, referring to both nozzles and tube sheets locations.

**Table 7.**  
Divertor PFC & Cassette HX main geometric data, [35].

Parameter	Value	
	PFC	CAS
No. of tubes	2369	4072
Tube OD (mm)	25.5	15.875
Tube Thickness (mm)	1.245	1.651
Tube Length (m)	3.972	13.159
Heat transfer area (m <sup>2</sup> )	750.8	2672.3
Dext vessel	2322/2346	2322/2346
(normal/reinforced zone) (mm)		
Shell thickness	8/20	32/48
(normal/reinforced zone) (mm)		

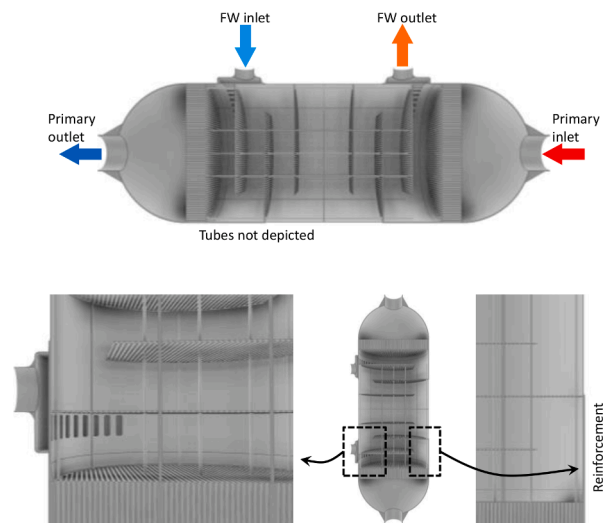

Fig. 14.. Preliminary CAD 3D model of the divertor HXs.

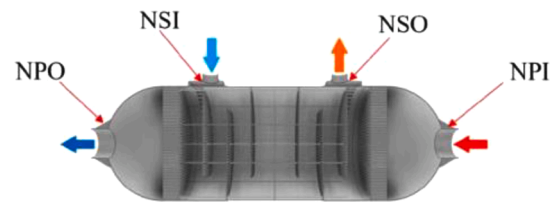

Fig. 15.. Nozzle position (NPO= Nozzle of primary coolant outlet, NPI=Nozzle of primary coolant inlet, NSO=Nozzle of secondary coolant outlet, NSI=Nozzle of secondary coolant inlet).

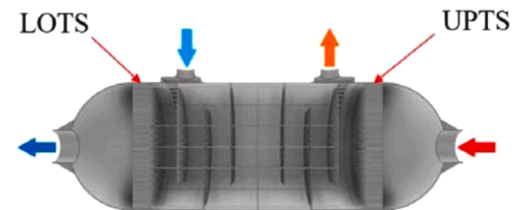

Fig. 16.. Position of the tube-sheets (LOTS=Lower tube sheet, UPTS=Upper tube sheet).

Moreover, it is evident that the lifetime is not problematic. In fact divertor cassette nozzles/tube-sheets lifetime is well above 10/30 FPY respectively, under the hypothesis of crediting the tube thermal stress in the UPTS/LOTS fatigue assessment. Regarding the tubes, lifetime predictions with all codes show long lifetimes for both heat exchangers.

A preliminary vibration analysis was also carried out to assess the maximum effective cross-flow velocity in the tube bundles with the aim to compare it with the critical one, namely that fluid velocity causing the onset the fluid-elastic instability [22,23]. The results indicate that the design of the divertor PFC heat exchanger is safe (i.e. the maximum cross-flow velocity in the HX is less than the critical one), but could represent a problem for the divertor cassette. A possible solution, which has a marginal (adverse) effect on the heat transfer and pressure loss, could consist of reducing the maximum unsupported span by means of the installation of partial support baffles to increase the strength of the tubes crossed by the flow.

5.2. The IHTS design description

The IHTS removes the power from the BB PHTS (see Fig. 2) and

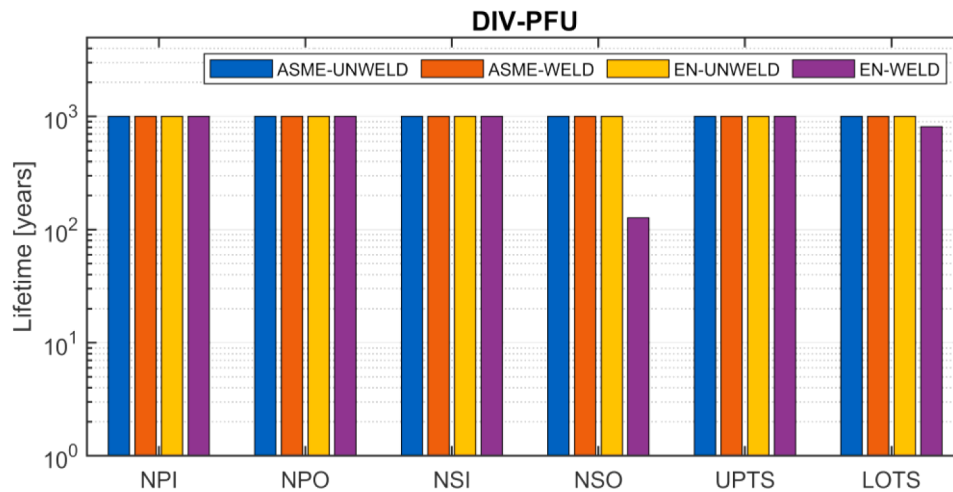

Fig. 17.. Lifetime prediction for the nozzles and tube plates of divertor PFC (NPO= Nozzle of primary coolant outlet, NPI=Nozzle of primary coolant inlet, NSO=Nozzle of secondary coolant outlet, NSI=Nozzle of secondary coolant inlet, (LOTS=Lower tube sheet, UPTS=Upper tube sheet).

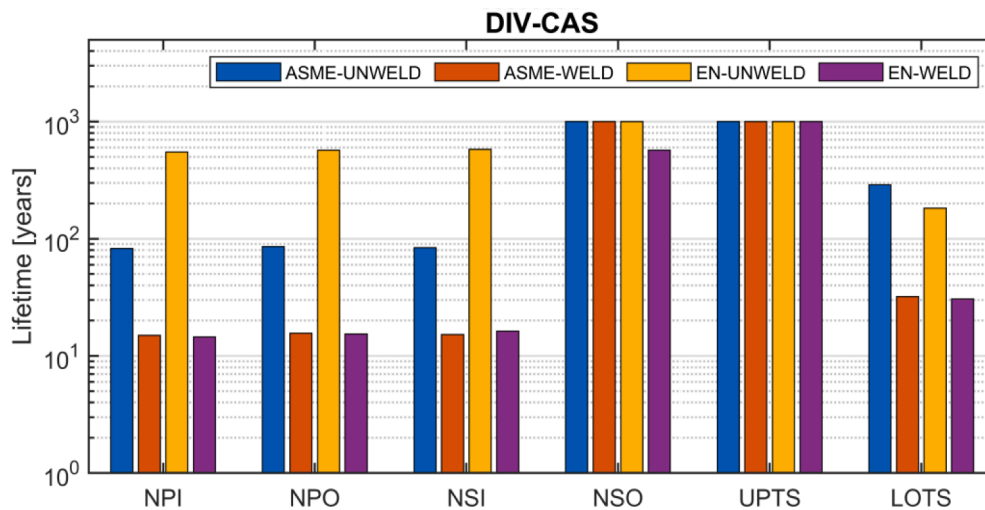

Fig. 18.. Lifetime prediction for the nozzles and tube plates divertor cassette HX.

transfers it to the ESS, then partially to the steam generators/superheaters for PCS pulse operation. It controls BB helium inlet temperature via main IHX secondary side, thus regulating HITEC inlet temperature and flowrate to IHX. During dwell, the HITEC mass flow rate through the IHX is adjusted to the needs of the BB decay heat removal. On PCS side of Fig. 2, it continues to flow as in the pulse phase, thus allowing PCS to deliver an almost constant power output. To achieve such a decoupling function (as well as for safety reasons), a group of 2/3 pumps is foreseen, both in the charging circuit of the IHTS (BB PHTS side) and the discharging circuit (PCS side). As suggested by the industrial partner involved, and according to common practice used in CSP the pumps are to be immersed in the ESS tanks.

For simplification, the ESS is realized as a classical two-tank solution; ESS energy storage capacity and MS inventory are shown in Tables 8 and 1.

Ongoing research in this area focusses on more compact single tank

solutions, which have the advantage of avoiding the costly high temperature HITEC pump and reducing space needed for the IHTS. For the MSSG, technical design and reliable cost estimates from industry are available. Industry also supplies the design for the turbo-generator interfacing the steam generator, as the interaction of these two large components has a high impact on system performance, as well as on space and cost optimization.

### 5.3. The PCS design description

During the PCD Phase, the PCS (see Fig. 2) was developed based on different design variants. All relevant usable energy (exergy) sources are included at pre-defined temperature and power level. The goal of the PCS design was to get a system as close as possible to existing Light Water Reactors to take advantage of the high availability of these proven components. Nevertheless, the non-steady conditions of the 'cold' energy sources (divertor and VV) makes the DEMO PCS design much more complex. The involvement of a lead industry supplier has enabled significant advances in the design and operating efficiency of an optimized turbine-feedwater train. The gross output of the Siemens SST5-6000 turbo-generator during dwell time is now even higher due to the reduced BB PHTS circulation power achieved with the latest BB PHTS design.

Table 8. HCPB ICD BoP ESS main parameters.

Parameter	Value
ESS capacity [MWh]	426
ESS hot/cold tank number	1/1

Table 9 summarizes the main design parameter of HCPB ICD BoP PCS.

#### 5.4. Feasibility and reliability assessment of the HCPB ICD BoP and open issues

##### 5.4.1. Design, manufacturing and functional feasibility

The DEMO HCPB ICD BoP concept is on a solid path. After the selection of ICD option as the main concept for HCPB BoP, the aim of PCD Phase was to enhance the maturity of the components, to be able to demonstrate ICD full feasibility (manufacturing & functional), as well as optimization potential for certain components [32]. An attempt was also made to rank the maturity through a preliminary technology readiness level (TRL) assessment of systems and components that should be integrated into the BoP concept, based on their operating conditions. Both the main interface between BB PHTS and IHTS (main IHX) and between IHTS and PCS (MSSG) were found to be the “critical” (see also the BoP variants ranking table in [8]), as neither of them were proven to be reliable in the highly dynamic DEMO operational environment. Moreover, the IHTS, the He-circulators and their operating behavior under DEMO conditions should be carefully investigated in a dedicated testing facility, which, while addressing the whole PHTS+IHTS heat transfer train, could demonstrate its functional feasibility. Decoupled from the IHTS, the performed TRL evaluation rated PCS components as being non-critical.

Four design options for the main He-MS IHX were examined and compared. A plate & shell design option, not investigated before, was found to be a very promising alternative to the reference shell and tube heat exchanger, albeit never used in nuclear power plants. These solutions will be further investigated and testing of a mock-up is currently planned in a dedicated experimental facility, to confirm the reliability in the DEMO operational environment.

The other critical interface component MSSG is currently based on a SG design from an industrial supported CSP design, which was not up-scaled or adapted, but multiplied in a modular approach to match DEMO requirements. This enables various optimization possibilities, among them the reduction of the number of MSSGs and thus the complexity and space requirement for a modular arrangement. Further work is required to increase the compactness of the MSSG in terms of surface area per unit volume. In addition to the aforementioned performance optimizations, the costs of the MSSG system can be reduced to one-third of the price by changing the material from high-alloy stainless steel to common carbon steel, should the design of IHTS assure the absence of any chloride impurities in the HITEC as a prerequisite.

The MS storage and transfer system components of the current IHTS concept are based on today’s CSP technology. Beside the classical two-tank-thermal storage system, the pros and cons of a single-tank (i.e. thermocline) and a modular approach with several smaller tanks (i.e. multi-tank) were investigated. A preliminary analysis showed that a thermocline setup has a comparatively low TRL, whereas a multi-tank setup has several advantages compared to the currently planned common two-tank system. In the context of the multi-tank system, the required MS transfer system can also be optimized, where centrifugal pumps can be used at ground level or on a small buffer tank, reducing operating costs and simplifies maintenance and operation.

In general, from today’s perspective, there exist no major concerns for the present DEMO HCPB ICD BoP concept with an IHTS.

Nevertheless, a verification should still be done through an experimental campaign in order to demonstrate its functional feasibility for DEMO relevant operation conditions. Also, the design finalization and optimization of the critical components must be done to reduce costs and minimize outstanding integration issues. Regarding the variant cost, as reported also in [8], a preliminary assessment of HCPB BoP ICD cost has been carried out [37]. The most expensive parts are the He circulators and the main heat exchangers, mainly caused by the lack of a competitive suppliers. In the CD phase, additional manufacturers will be contacted and variant costs will be refined to account for largest diameter pipe cost (i.e. diameter > DN 850) presently not accounted for in the project.

In order to identify potential suppliers for the He-circulators that are required for the PHTS loop, a market survey was also conducted. In general, several companies are available that can provide He circulators for DEMO application. However, at the moment there is no demand for other applications on these large circulators. Nevertheless, from the survey performed, a positive feedback from the market has been received with several companies providing preliminary budgetary price offers, regarding proposed pumping group configuration.

##### 5.4.2. Reliability

A preliminary reliability analysis has been conducted for the HCPB BoP ICD [40].

The FMEA study highlighted that an out of service of the DEMO reactor for weeks or months, due to undetected and unmitigated initiating events in the HCPB BoP (because of the aggravating failure of control systems), is not expected during the life of the plant. Instead, in case of detected and mitigated initiating events, *up to 5 events* can occur every year, requiring a break in DEMO operation. Furthermore, tens of events per year could induce a fault of a main component, such as the Circulator. It should be emphasized that the database for Helium and MS components are scarce compared to water based power conversion systems and, hence, data has to be extended in the CD Phase.

Moreover, the RBD analysis highlighted that the reliability to operate the HCPB ICD BoP for one full year without fault is of 0,03 %. Such a low value is mostly affected by the wide number of valves postulated in the IHTS+ESS and in the pressure control system of BB PHTS and steam turbine.

From RBD analyses provided, the predicted HCPB ICD BoP yearly operational and inherent availability are 49.26%–85.05%, respectively, in the first three years and decrease to 33.74% and 73.98% in the twentieth year of operation. Therefore, considering the preliminary targets requirements of 30% and 48%, both the three and twenty year data are compliant. Finally it is expected that these HCPB BoP performance should improve in the light of the actual DEMO operational concept envisaging around 2/5 FPY of first/second blanket operation [36].

## 6. Future work

An R&D plan is outlined with the purpose of demonstrating the feasibility and validating the performances of: (1) the WCLL BoP with “pulsed” PCS by demonstrating the functional feasibility of the WCLL BoP OTSG in the DEMO period as well as of the adequacy of a suitable Steam Turbine Low Pressure stage blade design and selected rotor material and (2) the components/systems of the HCPB BoP Indirect heat removal path, namely BB PHTS, IHTS+ESS.

### 6.1. WCLL BoP R&D plan

R&D activities are planned, in particular, on the “critical” interface component of the BoP, namely the Steam Generators of the BB PHTS of the WCLL BoP reference. Although the WCLL BB PHTS adopts components of well-proven technology since used in Nuclear (Fission) Power Plant, the water-water OTSG has an “unconventional” mode of

Table 9.

HCPB ICD BoP PCS main parameters, [1].

Parameter	Value
Gross Output (pulse/dwell) [MW]	892.5/930.0
Cycle efficiency (pulse/dwell)	37.6%/43.8%
Overall efficiency	34.1%
Steam turbine type	SST5-6000

operation, due to the pulsed nature of the plasma generated thermal power. Consequently, the general objective of water-water OTSG test campaign is to demonstrate the capability of the OTSG to perform as intended during the power phases of the DEMO period that, according to the present assumptions, consists of a 2 h pulse at full power followed by 10 min of dwell at decay power.

This scenario identifies three operational phases of the OTSG:

- The low (decay) power phase in the dwell period;
- The full power phase in the pulse period;
- The transient phase where the transition from pulse to dwell operation (and vice versa) occurs.

To achieve this, a new experimental facility, called STEAM, will be built at the ENEA Research Center of Brasimone to execute the following experimental campaigns:

1. Low Power Phase testing. It will consist of tests simulating the operation of the OTSG in dwell conditions (1% of nominal power), hence in a very challenging condition which is far from the recommended usual practice (around and over 5%). Main specific objectives are: i. the verification of the stable operation of the OTSG and the compliance of its performance to the specification in dwell, ii. the effectiveness of the adopted component regulation strategy, iii. the identification of the enveloping space of the allowed thermal hydraulic operational parameters for good operation in dwell; iv. the relevant thermal hydraulic data for assessment & qualification of numerical tools and design correlations at low power.
2. High Power Phase Testing. These tests, which would require an upgrade of the facility, are used to simulate the component operation during the pulse full power condition. Besides, it is not expected any OTSG operational issue in this operation mode, nevertheless, the tests are necessary to demonstrate the adequacy of the design and the reliability of the numerical simulations in support to it.
3. Pulsed-Dwell Phase Testing. This phase aims at performing tests simulating the operation of the OTSG during the pulse - dwell transition. The main purpose of these tests is to validate the performance and the suitability of the control strategy adopted. It will also include tests aiming at identifying the domain enveloping the operational T/H parameters for a safe, stable and efficient operation of the OTSG.

Moreover, WCLL “pulsed” Steam Turbine R&D activities, performed by industry, are planned in order to qualify a suitable Steam Turbine Low Pressure Stage blade design and rotor material of the “pulsed” PCS operating at very low load of the WCLL BoP Direct “No Storage” option.

In addition, it will provide fundamental information for qualification of LP ST design of the expected “milder” “pulsed” PCS operating at low load, relevant for reference WCLL BoP Direct Small ESS and back-up WCLL BoP Indirect Small ESS.

The planned activities consist of the following:

*Development and validation of ST low pressure blade design criteria for operation at very low load in DEMO dwell period.* It has to be noted that at very low load conditions the LP ST operates in large off-design mode, potentially dangerous since the possible occurrence of undue phenomena causing blade damage. These phenomena depend on the arrangement of the connection between HP ST and LP ST in dwell. In the case of LP HP and LP ST connected, the very low operational steam flowrate will lead the LP ST to operate in ventilation mode, a regime where there is the possibility of unsteady aerodynamic excitation on the blade with consequent high dynamic load, temperature increase and potential blade damage.

In the case of LP ST detached from the HP ST thanks to a clutch, the continuous rotational speed change at the transition pulse dwell-pulse will increase the fatigue cycles on LP ST; moreover the almost absent steam flow can trigger heavy unsteady phenomena” (i.e. flutter, ventilation, buffeting, etc.) inducing blade vibration and potential damage.

This R&D will address: i. the definition of the minimum steam flowrate (minimum load) for ST safe and reliable operation in ventilation mode (HP ST and LP ST aligned) and in heavy unsteady mode (LP ST detached from HP ST), ii. the development of blade design verification criteria under expected ventilation mode of operation or heavy unsteady mode, iii. the design of LP ST blade mock up and construction, iv. the test matrix definition and v. the LP ST blade testing at very low load (in both ventilation operation mode and heavy unsteady mode) as well as at low load (typical of the WCLL BoP reference). Further longer term R&D will address: vi. the post-processing of the experimental data and vii. the validation of blade verification criteria and their re-tuning to achieve new suitable updated criteria and a new blade concept design for optimization of LP ST operation in DEMO scenario.

1. *Selection and characterization of a ST rotor material for operation at very low load in DEMO dwell period.* This R&D has the following main objectives: (i) assessment of the applicability of the current rotor materials for “very low load” ST pulsating operating profile, (ii) identification of possible alternative materials to current ones and selection, (iii) identification of material data gaps/models to be covered/built for ST rotor design and life assessment, (iv) test matrix definition for data generation and material behavior assessment, (v) material supply and testing through service-like-cycles tests, (vi) rotor candidate material for very low power operation complete characterization.

## 6.2. HCPB BoP R&D Plan

As discussed above, the operation of the HCPB BoP ICD needs to be validated. So far the BoP systems have been investigated and adapted to the needs of DEMO. In the next phase, the BoP ICD will be updated and the validation of the reference HCPB BoP design concept will be pursued. An important step for reaching this objective is represented by the experimental campaign in the HELOKA-Upgrade Storage (US) new build facility, which will support the demonstration of the readiness and operability of the Helium cooling loop and the MS loop. To be flexible and to keep investment costs tolerable, a scale down factor of 1/1000 of a DEMO PHTS loop was chosen, allowing HELOKA-US to reproduce and study the pulse and dwell conditions encountered in the standard DEMO operation, as well as the critical pulse-dwell and dwell-pulse transitions. It will be constructed and operated at the Karlsruhe Institute of Technology (KIT).

The new facility will benefit from the existing HELOKA-HP [33] infrastructure developed for BB-design validation. The construction, commissioning and experimental campaigns of the project will consist of various sequential phases to optimize the resources, while minimizing the time and investment needed. First, a new MS scaled loop (see Table 10) will be constructed to preliminary test components and systems representing the IHTS and to qualify the main (scaled) IHX molten salt side. The MS loop will feature an electrical heater to simulate one main IHX to the BB PHTS side. In this initial phase, the IHTS heat sink will be the water cooling system of HELOKA facility [34]. The main issue in the MS loop is the heat transfer to the MS, which has to be checked and optimized for conditions corresponding to all different DEMO states of operation.

In parallel, the existing helium loop HELOKA-HP will be upgraded at the TBM Port 1 to cope with the BB-PHTS characteristics needed to be

**Table 10**  
HELOKA-US main actual features.

Parameter	Helium Loop	Molten Salt Loop
Thermal Power (kW)	250-280	
Temperature (°C)	300-550	300-465
Pressure (bar)	80	<6
Mass flow rate (kg/s)	0.24	1.10

simulated.

The coupling between the MS and He loops will be made via a full complete (scaled) IHX. The test campaign on this facility is aimed at the qualification of the steady state pulse/dwell performance of the IHX and of the MS loop components (such as MS pumps and valves), as well as of a possible optimized IHX aimed at achieving compactness. It will be possible to verify and validate the corresponding MS property correlations as well.

A further upgrade will be implemented at a later stage by connecting the MS loop to a (scaled) thermal ESS and to a (scaled) pressurized He loop representative of the HCPB BB PHTS including a DEMO (scaled)-dynamic temperature adaptive- helium circulator. With this upgrade, HELOKA-US will reach its full configuration for simulating the whole HCPB heat removal path of BB PHTS+IHXS+ESS. The full integrated facility, see a sketch in Fig. 19, will be fully operable with cutting-edge technologies and thus able to validate the BoP heat transfer chain design (and optimization), both at steady state and at pulse-dwell transitions with DEMO representative power ramp-up and ramp-down (thanks to a fast heater), using a prototypical He blower. The adopted design of the systems regulation scheme, the system & safety codes necessary to foster BoP simulation, and the safety assessments will be validated as well. Finally, the impact of the present facility scaling on the expected DEMO full scale system behavior will also be assessed in order to complete the experimental evaluation of the concept design of the HCPB ICD BoP.

## 7. Conclusions

This paper describes the effort conducted during the DEMO PCD Phase with the strong support of Industry, to develop a technically feasible, operable, maintainable and safe BoP design.

Several variants for both WCLL and HCPB BoP were investigated, permitting also to select the most promising option for each of the two BB concepts that are being considered as well as suitable optimization and back-up solutions. The approach followed has enabled the identification of areas in which there are significant technical uncertainties, and provide a clear basis for safety, reliability and cost analysis and further improvements.

A specific design and supporting R&D activity plan has been prepared which includes the following fundamental steps, involving the industry, namely: (i) the functional feasibility demonstration of the water-water WCLL OTSG of the BoP direct option and of a suitable LP ST blade and ST rotor of the “pulsed” PCS for operation at low/very low load in dwell, (ii) the feasibility and performance verification of components (such as the He circulators, the main He-MS IHX, the MS pumps and valves) & systems (i.e. the whole heat transfer loops) of the HCPB BoP indirect.

It is expected that this work will facilitate the required maturity the

BoP of a DEMO featuring a WCLL BB or a HCPB BB. In addition, it is expected that it will allow the extrapolation of feasibility considerations for a DEMO Plant. It is currently envisaged that DEMO acts as a Component Test Facility for the breeding blanket. This means that while operating with a near-full coverage “driver” blanket, which must be installed by day-1 to achieve tritium self-sufficiency and extract the thermal power and convert this into electricity, it must also be used to test and validate, in a limited number of dedicated segments, more advanced breeding blanket concept(s) that have the potential to be deployed in future fusions power plants [41]. Such flexibility and capabilities, however, have to be properly investigated early in the CD Phase and formalized as high level requirements, since they have major implications on the plant architecture and systems requirements.

Finally, there are some concerns arising from the fact that at present there are initiatives to reduce nuclear technology competence and expertise in several European countries. This could lead to adverse impact on some developments of relevance for the subject matters discussed in this paper.

## CRediT authorship contribution statement

**L. Barucca:** Conceptualization, Methodology, Investigation, Writing – original draft. **W. Hering:** Conceptualization, Methodology, Investigation, Writing – original draft. **S. Perez Martin:** Conceptualization, Methodology, Investigation, Writing – original draft. **E. Bubelis:** Conceptualization, Methodology, Investigation, Writing – original draft. **A. Del Nevo:** Conceptualization, Methodology, Investigation, Writing – original draft. **M. Di Prinzio:** Conceptualization, Methodology, Investigation, Writing – original draft. **M. Caramello:** Conceptualization, Methodology, Investigation, Writing – original draft. **A. D’Alessandro:** Conceptualization, Methodology, Investigation, Writing – original draft. **A. Tarallo:** Conceptualization, Methodology, Investigation, Writing – original draft. **E. Vallone:** Conceptualization, Methodology, Investigation, Writing – original draft. **I. Moscato:** Conceptualization, Methodology, Investigation, Writing – original draft. **A. Quartararo:** Conceptualization, Methodology, Investigation, Writing – original draft. **S. D’amico:** Conceptualization, Methodology, Investigation, Writing – original draft. **F. Giannetti:** Conceptualization, Methodology, Investigation, Writing – original draft. **P. Lorusso:** Conceptualization, Methodology, Investigation, Writing – original draft. **V. Narcisi:** Conceptualization, Methodology, Investigation, Writing – original draft. **C. Ciurluini:** Conceptualization, Methodology, Investigation, Writing – original draft. **M.J. Montes Pita:** Conceptualization, Methodology, Investigation, Writing – original draft. **C. Sánchez:** Conceptualization, Methodology, Investigation, Writing – original draft. **A. Rovira:** Conceptualization, Methodology, Investigation, Writing – original draft. **D. Santana:** Conceptualization, Methodology, Investigation, Writing –

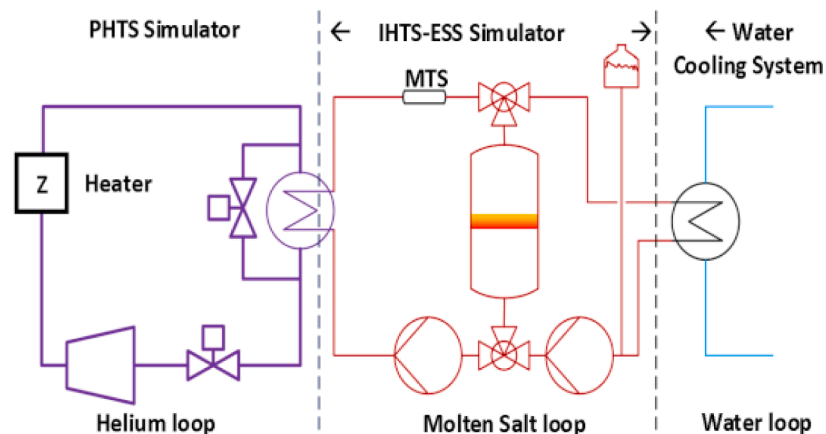

Fig. 19.. Schematics of HELOKA-US at the final phase.

original draft. **P. Gonzales:** Conceptualization, Methodology, Investigation, Writing – original draft. **R. Barbero:** Conceptualization, Methodology, Investigation, Writing – original draft. **M. Zaupa:** Conceptualization, Methodology, Investigation, Writing – original draft. **M. Szogradi:** Conceptualization, Methodology, Investigation, Writing – original draft. **S. Normann:** Conceptualization, Methodology, Investigation, Writing – original draft. **M. Vaananen:** Conceptualization, Methodology, Investigation, Writing – original draft. **J. Ylatalo:** Conceptualization, Methodology, Investigation, Writing – original draft. **M. Lewandowska:** Conceptualization, Methodology, Investigation, Writing – original draft. **L. Malinowski:** Conceptualization, Methodology, Investigation, Writing – original draft. **E. Martelli:** Conceptualization, Methodology, Investigation, Writing – original draft. **A. Froio:** Conceptualization, Methodology, Investigation, Writing – original draft. **P. Arena:** Conceptualization, Methodology, Investigation, Writing – original draft. **A. Tincani:** Conceptualization, Methodology, Investigation, Writing – original draft.

### Declaration of Competing Interest

The authors declare that they have no known competing financial interests or personal relationships that could have appeared to influence the work reported in this paper.

### Acknowledgments

This work has been carried out within the framework of the EUROfusion Consortium and has received funding from the Euratom Research and Training Programme 2014-2018 and 2019-2020 under grant agreement No 633053. The views and opinions expressed herein do not necessarily reflect those of the European Commission.

### References

- Barucca, L., Bubelis, S., Ciattaglia, A., D'Alessandro, A., Del Nevo, F., Giannetti, W., Hering, P., Lorusso, E., Martelli, I., Moscato, A., Quartararo, A., Tarallo, E., Vallone, Pre-conceptual design of EU DEMO balance of plant systems: objectives and challenges, *Fusion Eng. Des.* 169 (2021), 112504, <https://doi.org/10.1016/j.fusengdes.2021.112504>. August.
- Ciattaglia, S., et al., EU DEMO safety and balance of plant design and operating requirements. Issues and possible solutions, *Fusion Eng. Des.* 146 (2019) 2184–2188, <https://doi.org/10.1016/j.fusengdes.2019.03.149>.
- Cismondi, F., et al., Progress of the conceptual design of the European DEMO breeding blanket, tritium extraction and coolant purification systems, *Fusion Eng. Des.* 157 (2020), 111640, <https://doi.org/10.1016/j.fusengdes.2020.111640>.
- Mazzone, G., et al., EUROfusion-DEMO divertor - cassette design and integration, *Fusion Eng. Des.* 157 (2020), 111656, <https://doi.org/10.1016/j.fusengdes.2020.111656>.
- Mozzillo, R., et al., Design of the European DEMO vacuum vessel inboard wall, *Fusion Eng. Des.* 160 (2020), 111967, <https://doi.org/10.1016/j.fusengdes.2020.111967>. November.
- Barucca, L., et al., Status of EU DEMO heat transport and power conversion systems, *Fusion Eng. Des.* 136 (2018) 1557–1566, <https://doi.org/10.1016/j.fusengdes.2018.05.057>.
- Gaio, E., et al., The EU DEMO plant electrical system: issues and perspective, *Fusion Eng. Des.* 156 (2020), 111728, <https://doi.org/10.1016/j.fusengdes.2020.111728>.
- Moscato, I., et al., Tokamak cooling systems and power conversion system options, *Fusion Eng. Des.* 178 (2022) 113093, <https://doi.org/10.1016/j.fusengdes.2022.113093>.
- Bubelis, E., et al., Industry supported improved design of DEMO BoP for HCPB BB concept with energy storage system, *Fusion Eng. Des.* 146 (2019) 2334–2337, <https://doi.org/10.1016/j.fusengdes.2019.03.183>.
- Coastal Chemical Co. LLC, Hitec heat transfer salt, Report of Coastal Chemical Co. LLC, Houston, TX.
- Malinowski, L., et al., Design and analysis of the secondary circuit of the DEMO fusion power plant for the HCPB BB option without the energy storage system and with the auxiliary boiler, *Fusion Eng. Des.* 160 (2020), 112003, <https://doi.org/10.1016/j.fusengdes.2020.112003>.
- Sanguinetti, G., BOP-2.2-T041-D001 & BOP-2.2-T041-D002 preliminary feasibility considerations of the direct coupling of WCLL BB PHTS to PCS with “no storage”, EUROfusion internal deliverable, IDM Ref. EFDA\_D\_2NHFT4.
- Tarallo, A., BOP-2.2-T024-D001 Preliminary mechanical design and verification of WCLL BB PHTS once through steam generator (OTSG), EUROfusion internal deliverable, IDM Ref. EFDA\_D\_2MT77PL.
- Kitto, J.B., Stultz, S.C., *Steam, its Generation and Use*, 41st ed., The Babcock & Wilcox Company, Barberton, Ohio, U.S.A., 2005.
- Cumo, M., Naviglio, A., *Thermal Hydraulic Design of Components for Steam Generation Plants*, CRC Press, Boca Raton, 2018.
- Snakovich, M.F., McDonald, B.N., *Once-Through Steam Generation*, in: *Proceedings of the XVI Nuclear Congress, Babcock&Wilcox, Rome, Italy, 1971*, pp. 25–26. March.
- Rovira, A., BOP-2.2-T024-D002 Preliminary thermo-mechanical analysis of WCLL BB PHTS once through steam generator (OTSG), EUROfusion internal deliverable, IDM Ref. EFDA\_D\_2NWXDZ.
- European Standard EN 12952-3, Water-tube boiler and auxiliary installations – part 3: design and calculation for pressure parts, 2011.
- American Society of Mechanical Engineers. ASME Boiler and Pressure Vessel code, Section III, Division 1, Subsection NB, 2010.
- American Society of Mechanical Engineers. ASME Boiler and Pressure Vessel code, Section III, Division 1, Appendices, 2010.
- European Standard EN 13445-3, Unfired pressure vessels – Part 3: Design, 2014.
- Engineering Sciences Data Unit (ESDU), Flow induced vibration in tube bundles with particular reference to shell and tube heat exchangers, 1987.
- Verein Deutscher Ingenieur (VDI), VDI heat atlas. *Vibration of Tube Bundles in Heat Exchangers*, 2nd ed., Springer, 2010.
- Pinna, T., L.C. Cadwallader, Component Failure rate data base for fusion applications, *Fusion Eng. Des.* 51-52 (2000) 579–585.
- Pinna, T., Fusion component failure rate database (FCFR-DB), *Fusion Eng. Des.* 81 (2006) 1391–1395.
- Väänänen, M., J. Ylätalo, PMI-3.2-T041-D002 WCLL BB PHTS&BOP direct coupling option (Aux. Boiler) – impact of low load operation on relevant plant components, EUROfusion internal deliverable, IDM Ref. EFDA\_D\_2MM3YF.
- Del Nevo, A., BOP-2.2-T013-D001 Direct coupling of WCLL BB PHTS to PCS feasibility study - preliminary PCS design with an internal source of energy to operate at a minimum load the steam turbine and the power cycle in dwell, EUROfusion internal deliverable, IDM Ref. EFDA\_D\_2MN55V.
- Sanguinetti, G., BOP-2.2-T022-D001 Direct Coupling of WCLL BB PHTS to PCS feasibility study finalization: PCS with “Small ESS “transient analysis and components stress evaluation, EUROfusion internal deliverable, IDM Ref. EFDA\_D\_2N8BT8.
- M.V. Bologa, E. Bubelis, W. Hering, Parameter study and dynamic simulation of the DEMO intermediate heat transfer and storage system design using MATLAB/Simulink, *Fusion Eng. Des.* 166 (112291) (2021) 1–8. ISSN 0920-3796 /Paper.
- Moscato, I., et al., BOP-2.1-T056-D002 HCPB BB PHTS DDD (Indirect Coupling Option), EUROfusion internal deliverable, IDM Ref. EFDA\_D\_2NV9LP.
- Perez-Martin, S., et al., BOP-2.1-T035-D001 HCPB PHTS&BOP SRD (Indirect Coupling Option), EUROfusion internal deliverable, IDM Ref. EFDA\_D\_2MUCM8.
- Moscato, I., et al., BOP-2.1-T056-D002 HCPB BB PHTS DDD-Long version, EUROfusion internal deliverable, IDM Ref. EFDA\_D\_2NZL6Z.
- Jin, X.Z., Bubelis, E., Ghidersa, A.F., Badae, “HELOKA-HP thermal-hydraulic model validation and calibration”, *Fusion Eng. Des.* 109–111 (2016) 1242–1246, <https://doi.org/10.1016/j.fusengdes.2015.11.054>. VolumesPart B.
- Hering, W., Jin, X.Z., Bubelis, E., Perez-Martin, S., Ghidersa, A.F., Operation of the helium cooled demo fusion power plant and related safety aspects, IAEA-TECDOC-13657, 2020, <https://www.iaea.org/publications/13657/challenges-for-coolants-in-fast-neutron-spectrum-systems>.
- Vallone, E., et al., Pre-conceptual design of EU-DEMO divertor primary heat transfer systems, *Fusion Eng. Des.* 169 (2021), 112463, <https://doi.org/10.1016/j.fusengdes.2021.112463>.
- Bachmann, C., Operational concept document for demo, EUROfusion internal deliverable, IDM Ref. EFDA\_D\_2MALAP.
- Bubelis, E., BOP-3.1-T012-D001 HCPB PHTS&BOP Costs Overview (Indirect Coupling Option), EUROfusion internal deliverable, IDM Ref. EFDA\_D\_2NSZ4M. <https://www.ebsilon.com/en/>.
- Official apros website: <https://www.apros.fi/applications/safety-analysis/>.
- Pinna, T., et al., RAMI analyses for the primary heat transfer systems of breeding blankets and the related balance of plant of DEMO reactor, *Fusion Eng. Des.* 170 (2021) 112505, <https://doi.org/10.1016/j.fusengdes.2021.112505>.
- Federici, G., et al., An overview of the EU breeding blanket strategy as integral part of the DEMO design effort, *Fusion Eng. Des.* 141 (2019) 30–42.
- Ciattaglia, S., et al., Key EU DEMO plant and building layout criteria, *Fusion Eng. Des.* 171 (2021), 112567. October.
- Hering, W., et al., Overview of thermal hydraulic optimization and verification for the EU-DEMO HCPB BOP ICD variant, *Energies* 14 (2021) 7894, <https://doi.org/10.3390/en14237894>.

### Further reading

- General Electric Company, GateCycle 6.1.3.0.
- Rovira, A., BOP-5-T010-D001 Answer to DR comments on CIEMAT-UNED thermo-mech calcs on analysed WCLL/HCPB PHTS&PCS components, EUROfusion internal deliverable, IDM Ref. EFDA\_D\_2NXPMB.